

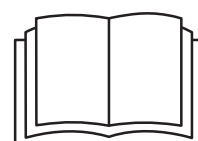

Operation, Safety, Maintenance and service Manual

Original Instructions - Keep this manual with the machine at all times.

Self-propelled Tracked Platform **LIGHTLIFT 17.75** **Serie IIS**



MULL177520113

HINOWA LIFT
FOREWORD

Contact:

HINOWA SPA
Via Fontana
37054 Nogara - Verona
Italy

Phone: +39 0442 539100
Fax: +39 0442 539075
E-mail: hinowa@hinowa.it

*Original languages of the manufacturer: Italian and English.
All other languages are copies of the original instructions.*

HINOWA LIFT
FOREWORD

Manual code	Date edition	Description of the review
MULL177520512	May, 2012	Original Issue
MULL177520113	January, 2013	<ul style="list-style-type: none">• The emergency control key on the ground stop box has been replaced with a selector.• The hand control screws of the ground part proportionals have been replaced with two bellows buttons.• Added data on sound power level of the motors• Amended paragraph "8.2 loading and unloading with ramps".• Added paragraph "8.3.1 lifting of the machine using a forklift".• Settled some texts.

TABLE OF CONTENTS

CHAPTER	1	PRESENTATION	Page 07
CHAPTER	2	TECHNICAL INFORMATION	Page 08
	2.1	Description of the machine	Page 08
	2.1.1	Control position	Page 08
	2.1.2	Machine identification plate	Page 11
	2.1.3	Overall dimensions of the machine	Page 12
	2.1.4	Technical specifications	Page 13
	2.1.4.1	Petrol engine technical specifications	Page 14
	2.1.4.2	Diesel engine technical specifications.....	Page 14
	2.1.4.3	Hydraulic system technical specifications	Page 14
	2.1.4.4	Electrical system technical specifications Thermic	Page 14
	2.1.4.5	Electrical system technical specifications Lithium	Page 15
	2.1.5	Terminology	Page 15
	2.2	General safety standards	Page 17
	2.3	Safety warnings.....	Page 21
	2.3.1	Generalities	Page 21
	2.3.2	Noise and vibrations	Page 21
	2.3.3	Pictograms positioned on the machine	Page 22
CHAPTER	3	SAFETY DEVICES	Page 36
	3.1	Battery cutout switch	Page 37
	3.2	Distributor pressure relief valves	Page 37
	3.3	Cylinder stop valves	Page 38
	3.4	Alignment photocell on the aerial part of the structure and the base of the machine	Page 38
	3.5	Stabiliser position microswitches	Page 39
	3.6	Jib position microswitch	Page 39
	3.7	Basket load sensor	Page 40
	3.8	Control protection	Page 41
	3.9	Spirit level	Page 41
	3.10	Pin locking bolts and nuts	Page 42
	3.11	Safety device electronic control board.....	Page 42
CHAPTER	4	INSTRUMENTS AND CONTROLS	Page 44
	4.1	Remote control	Page 44
	4.1.1	Display	Page 45
	4.1.1.1	Display main screen	Page 45
	4.1.2	Joysticks	Page 49
	4.1.3	Push buttons.....	Page 51
	4.2	Footswitch	Page 55
	4.3	Control positions	Page 55
CHAPTER	5	EMERGENCY DEVICES	Page 56
	5.1	Emergency stop button.....	Page 56
	5.2	Hand pump	Page 57
	5.3	Solenoid valves for emergency descent.....	Page 57
	5.4	Safety device bypass key	Page 57
	5.5	Emergency position controls	Page 59
CHAPTER	6	USING THE MACHINE.....	Page 64
	6.1	Safety standards to adopt before using the platform	Page 64
	6.1.1	Risk of electrocution.....	Page 64
	6.1.2	Danger due to atmospheric conditions	Page 65
	6.1.3	Danger due to the work area	Page 65
	6.2	Procedures for correct use	Page 66
	6.2.1	Summary table of operator safety standards	Page 66
	6.3	Working area	Page 68
	6.4	Using the elevating work platform (MEWP)	Page 69

6.4.1	Preliminary checks before starting work	Page 70
6.4.2	Starting the petrol/diesel engine	Page 71
6.4.3	Starting the electric motor	Page 72
6.4.4	Stopping the engine/motor	Page 74
6.4.5	Stopping the motor lithium version	Page 74
6.4.6	Travel	Page 75
6.4.7	Jib arm movement for travel	Page 78
6.4.8	Parking the machine on a slope or on uneven ground	Page 80
6.4.9	Stabilising and levelling the machine	Page 80
6.4.10	Automatic lowering and raising of the stabilisers	Page 84
6.4.11	Track gauge extension.....	Page 86
6.4.12	Moving the basket	Page 87
6.4.13	Manually levelling the basket	Page 91
6.5	Emergency operations on the aerial part	Page 92
6.5.1	Emergency descent controlled from the basket	Page 92
6.5.2	Operating the machine from the emergency control position on the ground if the operator is taken ill	Page 93
6.5.3	Emergency descent in the case where the stabilisers are accidentally retracted	Page 94
6.5.4	Emergency descent controlled from the ground using the hand pump in the event of faults on all energy supply systems	Page 96
6.5.5	Emergency operations on the carriage: moving the platform stabilisers using the hand pump to allow the machine to be transported.....	Page 98
6.5.6	Emergency operation of the undercarriage in the event of movements of the aerial part	Page 99
6.6	Electrical disconnection of the remote control	Page 101
6.7	Recharging the battery	Page 102
6.8	Main intended uses of the platform	Page 106
6.8.1	Systems.....	Page 106
6.8.2	Closed environments	Page 106
6.8.3	Pruning.....	Page 106
6.8.4	Repair and maintenance of roofing and gutters	Page 107
6.8.5	Painting, sand-blasting and plastering.....	Page 107
6.8.6	Use in marine environments	Page 107
CHAPTER 7	MAINTENANCE.....	Page 108
7.1	Safety instructions for greasing and lubrication.....	Page 108
7.2	Table of recommended lubricants.....	Page 108
7.3	Greasing points.....	Page 110
7.4	Greasing the telescopic arm	Page 111
7.5	Safety instructions for maintenance operations.....	Page 111
7.6	Operating the machine from the second control position on the ground using the optional second remote control during maintenance	Page 112
7.7	Periodic maintenance intervals	Page 113
7.8	Electric motor	Page 115
7.8.1	Electric motor maintenance	Page 115
7.9	Inspection and maintenance	Page 116
7.10	General periodic checks	Page 118
7.11	Maintenance on the rubber tracks	Page 119
7.11.1	Checking the track tension.....	Page 119
7.11.2	Loosening/tightening the tracks.....	Page 119
7.11.3	Checking the rubber tracks	Page 120
7.11.4	Replacing the rubber tracks	Page 122
7.12	Checking tightness of nuts and bolts.....	Page 123
7.13	Checking the hydraulic oil level.....	Page 127
7.13.1	Hydraulic oil.....	Page 127
7.14	Checking for leaks in the hydraulic system.....	Page 127

	7.15	Checking the condition of the filter cartridge	Page 128
	7.16	Checking that all the plates are present on the machine and intact	Page 128
	7.17	Checking the operating pressure of the hydraulic system	Page 129
	7.18	Checking tightness of the fastening screws on the pin retainers and the locknuts.....	Page 129
	7.19	Checking wear on the extension arm internal sliding ring	Page 130
	7.20	Checking wear on the telescopic arm slides	Page 130
	7.21	Checking tightness of the turntable bolts.....	Page 131
	7.22	Battery: checks and maintenance - thermic version	Page 131
	7.22.1	Checking the electrolyte level - thermic version	Page 131
	7.22.2	Recharging the battery - thermic version.....	Page 132
	7.22.3	Replacing the battery - thermic version	Page 133
	7.22.4	Battery disposal	Page 133
	7.23	Battery pack operating specifications.....	Page 134
	7.23.1	Components and diagrams	Page 135
	7.23.2	Personal protective equipment.....	Page 137
	7.23.3	Handling in dangerous conditions	Page 137
	7.23.3.1	Procedure for handling hot cells	Page 138
	7.23.3.2	Procedure for handling vented cells.....	Page 139
	7.23.3.3	Procedure for exploded cells.....	Page 140
	7.23.3.4	Lithium battery fire	Page 142
	7.24	Servicing the engine	Page 144
CHAPTER	8	SAFETY STANDARDS FOR TRANSPORT	Page 145
	8.1	Removing the basket.....	Page 145
	8.2	Loading and unloading the machine on transport vehicles using ramps	Page 146
	8.3	Lifting the machine.....	Page 148
	8.3.1	Lifting the machine using a forklift	Page 149
	8.3.2	Lifting the machine using ropes or chains	Page 150
	8.4	Transporting the machine.....	Page 151
CHAPTER	9	SERVICE MENU ON THE REMOTE CONTROL	Page 152
	9.1	Input menu	Page 152
	9.2	Error menu.....	Page 154
	9.3	Operating hours menu.....	Page 154
	9.4	Settings menu.....	Page 154
	9.5	Joystick menu	Page 154
CHAPTER	10	TROUBLESHOOTING.....	Page 155
CHAPTER	11	CHECKS TO BE COMPLETED ON THE MACHINE FOLLOWING REPAIRS.....	Page 163
	11.1	Checking correct operation of the controls.....	Page 163
	11.2	Checking operation of the safety devices.....	Page 163
CHAPTER	12	HYDRAULIC SYSTEM	Page 164
	12.1	Hydraulic system diagram thermic version	Page 164
	12.1.1	Key to the hydraulic system diagram thermic version	Page 165
	12.2	Hydraulic system diagram lithium version.....	Page 166
	12.2.1	Key to the hydraulic system diagram lithium version.....	Page 167
CHAPTER	13	WIRING DIAGRAM	Page 168

PREFACE

The aim of this manual is to provide the user with the necessary instructions and essential operating procedures to ensure correct and safe use of the machine for its intended purposes, as well as to prevent serious injury to the operator and other persons.

IMPORTANT

IT IS MANDATORY TO KEEP TO ALL THE INSTRUCTIONS GIVEN IN THIS MANUAL. THIS MANUAL MUST BE CAREFULLY READ AND UNDERSTOOD BEFORE OPERATING THE MACHINE.

As this manual is an essential work tool, it must be kept with the machine at all times, in the special compartment, so as to be available for clarification whenever required.



As the manufacturer cannot control the conditions of the machine and the operations this is used for, THE USER IS RESPONSIBLE for ensuring compliance with the safety procedures described in this manual.

Every machine supplied is thoroughly adjusted and tested before being delivered. The operator does not need to perform any adjustments before using the machine.

Every alteration and/or modification of the features of the original machine design without previous written authorisation from the Constructor are PROHIBITED and THE RESPONSIBILITY FOR THESE ACTIONS FALLS ON THE OPERATOR.

THE EMPLOYER MUST MAKE SURE THAT THE OPERATOR HAS THE REQUISITES NECESSARY TO OPERATE THE MACHINE CORRECTLY AND THAT SUCH OPERATOR HAS CAREFULLY EXAMINED AND UNDERSTOOD THE INFORMATION GIVEN IN THIS USER AND OPERATION MANUAL, RECEIVING SUITABLE TRAINING REGARDING USE OF THE MACHINE IN STANDARD AND EMERGENCY CONDITIONS.

THE EMPLOYER MUST ALSO TRAIN OPERATORS REGARDING ANY NATIONAL STANDARDS THAT ARE IN ADDITION TO THE INSTRUCTIONS CONTAINED IN THIS DOCUMENT.

If the manual is damaged or lost, a copy must be requested directly from HINOWA.

Note: All of the photos and drawings in this manual have been added to simplify comprehension by the reader. Your machine may differ from the photos and drawings provided.

NORMATIVE REFERENCES

The machine has been designed, built and inspected according to that prescribed in the EN280 prA2:2009 harmonised standard, which supplies the presumption of conformity with the Essential Safety Requisites of the 2006/42/CE Machinery Directive even if a type C Voluntary Technical Standard.

According to that stated in EN280 prA2, the HINOWA platform is classified in GROUP B, as the vertical projection of the centre of gravity of the load can be outside of the tilting lines and in TYPE 1 as traversing is only allowed with the platform at rest.

The stability tests of the machine have been made in accordance with what described in paragraph 6.1.4.2 of the EN280 with load test calculated in conformity with 5.2.4 and have been successful.

In addition what prescribed in this manual it is necessary to apply the technical requirements of the following national/international safety standards:

- UNI ISO 18893
- ISO 16368
- ISO 18878

With the exception of stricter local or national regulations in the working area of the MEWPS.

WARRANTY

On purchasing a HINOWA platform, a warranty and inspection certificate is issued that clearly indicates the warranty terms and where any interventions on the machine must be reported.

LIABILITY

The Constructor is exonerated from any liability and obligation for any injury/damage caused to persons/objects due to any of the reasons listed below:

- Failure to comply with the instructions indicated in this USE AND MAINTENANCE MANUAL regarding running, use and maintenance of the machine;
- Violent or sudden actions or incorrect manoeuvres when using or servicing the machine;
- Modifications made to the structure or machine components without previous authorisation from the Constructor and/or without the use of suitable equipment;
- Strange events with respect to normal and correct use of the machine, described in this USE AND MAINTENANCE MANUAL.
- Use of non-original spare parts not authorised by the manufacturer.

EC DECLARATION OF CONFORMITY

07239600



PIATTAFORME AEREE - MINIDUMPERS - TRANSPALLET - CARRI CINGOLATI

Nogara,

DICHIARAZIONE DI CONFORMITA' CE

EC DECLARATION OF CONFORMITY

LA SOCIETA' HINOWA S.p.A. con sede in VIA FONTANA-37054 NOGARA (VR) ITALIA
THE COMPANY HINOWA S.p.A. main office in VIA FONTANA-37054 NOGARA (VR) ITALY

**DICHIARA
DECLARES**

SOTTO LA PROPRIA ESCLUSIVA RESPONSABILITÀ CHE IL PRODOTTO DENOMINATO
ON ITS OWN EXCLUSIVE RESPONSIBILITY THAT THE PRODUCT CALLED

"PIATTAFORMA DI LAVORO ELEVABILE MOBILE "

" MOBILE ELEVATING WORKING PLATFORM "

MODELLO / MODEL	
MATRICOLA / SERIAL NUMBER	
ANNO DI COSTRUZ. / CONSTRUCTION YEAR	

AL QUALE QUESTA DICHIARAZIONE SI RIFERISCE, E' CONFORME AI REQUISITI
ESSENZIALI DI SICUREZZA PREVISTI DALLA DIRETTIVA 2006/42CE, 2004/108/CE, 2006/95/CE E SUCCESSIVE MODIFICHE, E
DALLE NORME EN ISO 12100-1:2003/A1:2009; EN ISO 12100-2:2003/A1:2009; EN60204-1, EN13857:2008, EN349:1993/A1:2008
EN280:2001, EN280:2001+A2:2009.

E' INOLTRE IDENTICA ALLA MACCHINA OGGETTO DEL

TO WHICH THIS DECLARATION REFERS, COMPLIES WITH THE ESSENTIAL SAFETY REQUIREMENTS PROVIDED FOR BY
DIRECTIVES 2006/42 CE, 2004/108/CE, 2006/95/CE AND SUBSEQUENT MODIFICATIONS, AND BY NORMS EN ISO 12100-
1:2003/A1:2009; EN ISO 12100-2:2003/A1:2009; EN60204-1, EN13857:2008, EN349:1993/A1:2008 EN280:2001, EN280:2001+A2:2009.

IS IDENTICAL TO THE MACHINE WHICH IS THE SUBJECT-MATTER OF THE
CERTIFICATO DI ESAME CE N° /CERTIFICATION CE TYPE N° DEL /DATED

Rilasciato da/ Released by: ECO S.p.A. Via Mengolina, 33 - 48018 Faenza (RA)

Organismo Notificato n°/ Notified Organization n°. 0714

La persona autorizzata a costituire il Fascicolo Tecnico è:/ The person authorised to compile the Technical file is

Fracca Dante c/o HINOWA S.p.A. via Fontana 37054 Nogara -VR- Italia

La macchina è inoltre conforme alla direttiva 2000/14 CE come da decreto di recepimento n.262 del 04/09/02.

Furthermore the machine complies with the provisions of "noise emission in the environment by equipment for use outdoors" directive 2000/14 CE

Tipo di macchina:Piattaforma aerea di accesso con motore a combustione interna/ <i>Type of equipment :Combustion engine aerial platform</i>	1 All. 1
Potenza netta installata/ Net installed powern	
Procedura seguita per la valutazione della conformità / <i>Procedure applied for the conformity assessment</i>	Allegato V
Potenza sonora misurata/ Measured sound power level	
Potenza sonora garantita/ Guranted sound power level	

HINOWA s.p.a. - Via Fontana - 37054 NOGARA (Verona) - ITALIA - Tel. +39 (0)442 539100 - Telefax +39 (0)442 539075 - E-mail: hinowa@hinowa.it
web site: www.hinowa.com - Reg. Impr. C.C.I.A.A. 01996640239 - R.E.A. 210602 - Cod. Fisc. e Part. Iva IT 01996640239 - Cap. Soc. € 1.500.000,00 I.v.

1. PRESENTATION

This manual describes the warning signs used to draw the reader's attention to several particularly important warnings.

The safety warnings are divided into two main types, which are identified and described below.

DANGER

This symbol accompanied by the word DANGER indicates that the situation described, if not prevented, can lead to serious injury or death of the persons involved (operator, ground staff, staff present in proximity to the platform, maintenance technicians etc.).



WARNING

This symbol accompanied by the word WARNING indicates that the situation described represents a potential risk for the structure of the machine.

Dangerous situations may be determined by this condition (including injury or death) for the persons involved.



2. TECHNICAL INFORMATION

2.1. DESCRIPTION OF THE MACHINE

The HINOWA machine is a self-propelled hydraulic lifting device, equipped with a rotating work basket positioned at the top of an extendable articulated structure, which also rotates. The HINOWA lifting device is destined for the POSITIONING OF PERSONS AND THEIR EQUIPMENT AND MATERIALS IN HIGH POSITIONS WITH RESPECT TO GROUND LEVEL.

2.1.1 CONTROL POSITION

- CONTROL POSITION IN THE BASKET

The HINOWA overhead platform has been designed to be controlled by the operator in the basket using a remote control, where all of the machine functional controls are gathered, positioned in the relevant support inside the basket (see photo). A optional pedal button is also present in the basket to allow movement of the aerial part (photo). From this control position it is possible to control the extendible structure and machine stabilisation. When the machine is manoeuvred from the control position in the basket, the remote control must be positioned in the appropriate seat, and the footswitch must be pushed (the footswitch must be release and pressed again if no movements are made for more of 7 second). The remote control is connected to the machine using a flexible cable that allows to shift it if the basket is to be removed or the ground control unit is to be used.

Stabilisation of the machine must be preferably controlled from the basket drive position. Machine traversing must be carried out from the control position on the ground.



WARNING

After accessing or leaving the control position in the basket, ALWAYS remember to close the ladder, to avoid any damage when operating the machine.

After leaving the control position in the basket, always remember to close the remote control protection cover.

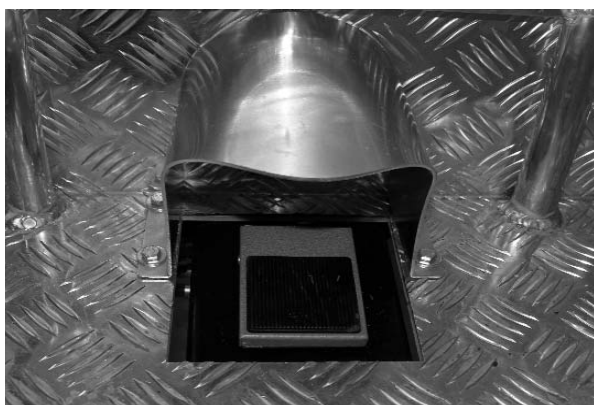

CONTROL POSITION ON THE GROUND:

There is a second control position available for the tracked part of the machine. This is not in a fixed position but rather can be located on the ground within a radius of 2.5 m from the basket attachment. To control the machine from this position, the operator uses the same remote control, removing it from its housing in the basket and using the cable provided.



From this control position, the operator **IS NOT** enabled to control the aerial part of the machine, but only the tracks, stabilisers and track extension function.



WARNING! when controlling the machine from the ground position, keep a distance of at least 1 m from the tracks.



WARNING! when controlling the machine from the ground position, always make sure that the component that is being moved is completely visible and constantly check its trajectory.

- EMERGENCY CONTROL POSITION

There is a control position which will be identified as the emergency control position. This is located on the ground part of the machine, next to the distributor for the aerial part. To enable it, press the special selector positioned on the base of the turret (see photo) until the green warning light comes on. The light indicates that the movements of the aerial part are enabled.



THERMIC MOTOR



LITHIUM MOTOR

From this position, the movements of the machine can be controlled directly using the levers on the various hydraulic distributors, aerial part (see photo 1) and proportional (aerial part, see photo 2).



WARNING

The emergency control position was designed to operate on the extensible structure only for emergency operations by emergency service personnel on the ground, who must in any case be trained and know the operation of the machine and its safety devices, as well as for maintenance and checks before starting work.

If an operator is in the basket, it is forbidden to move the structure from the ground position, unless in an emergency situation (sudden operator illness, technical fault).



There is a control position available only for scheduled and unscheduled maintenance operations, placed near the electrical components compartment on the machine. On the electric board protection there is an auxiliary connector for the connection of the optional second remote control (see photo).



OPTIONAL SECOND REMOTE CONTROL CONNECTOR POSITION



OPTIONAL SECOND REMOTE CONTROL CONNECTOR

To enable this position, use the key selector placed on the base of the turret and connect the optional second remote control to the machine.

Before proceeding with the connection, carefully read the paragraph regarding the use of the optional second remote control.



WARNING

This control position can only be used to carry out checks and maintenance on the machine. Do not use this position to control the machine during normal operations.

Note: it is absolutely forbidden to move the machine from this position if one or more operators are in the basket.

SELF-PROPELLED TRACKED PLATFORM LL1775

HINOWA

2.1.2 MACHINE IDENTIFICATION PLATE

The manufacturer plate is placed on the protection of the aerial part hydraulic distributor.

The drawing is shown below.



	HINOWA S.p.A. Via Fontana 37054 NOGARA (VR) ITALIA Tel. +39-0442 539100 Fax. +39-0442 539075 hinowa@hinowa.it www.hinowa.com	
Miniscavatori - Carri cingolati Minidumper - Piattaforme aeree Pale compatte		
Modello PLE / Model MEWP _____		
Matricola / Serial n° _____		
Anno di costruzione / Year of construction _____		
Massa MEWP / Weight MEWP _____ kg		
Pressione max impianto idraulico Hydraulic circuit max pressure _____ bar		
Portata / Capacity max _____ kg		
Comprende: n°2x80 Kg persone + 40 kg di attrezzatura / Include: n°2x80Kg person + 40 Kg equipment		
Velocità max. vento ammessa Max wind speed allow 12,5 m/s		
Forza manuale max ammessa Max manual strength allow 400 N		
Inclinazione max telaio ammessa Maximum allow inclination 1 °		
Alimentazione elettrica esterna Electric power system _____ V _____ Hz		

SELF-PROPELLED TRACKED PLATFORM LL1775

HINOWA

2.1.3 OVERALL DIMENSIONS OF THE MACHINE

Maximum length in travel configuration with basket installed	4529 mm
Track width	798/1086 mm
Maximum height in travel configuration with foot plates removed	2000 mm
Maximum attachment angle.....	20°
Maximum stabilisation angle	12°
Max stabiliser base side (disc centre)	2890x2885 mm

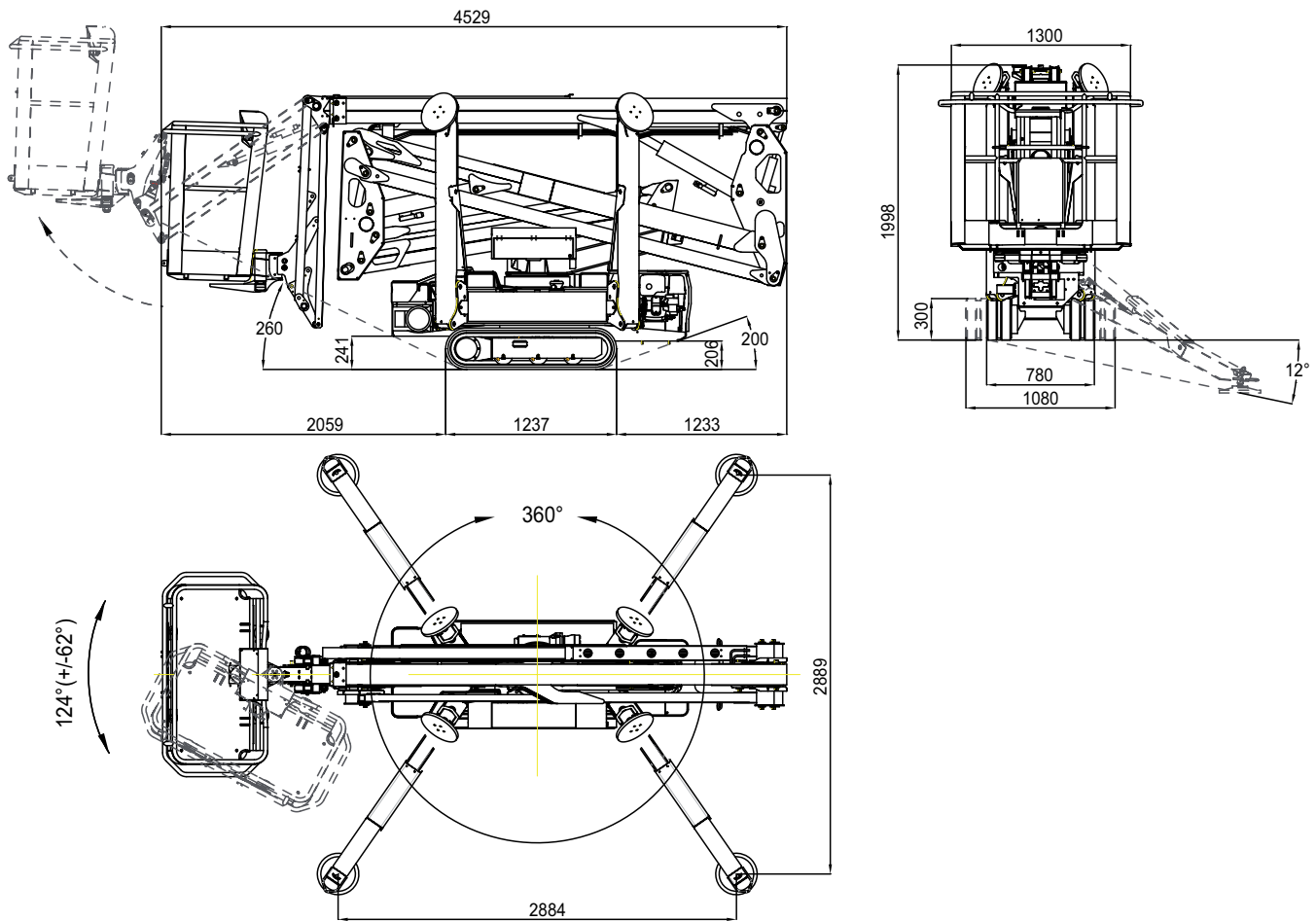

Nota: standard version with two-operator basket.

SELF-PROPELLED TRACKED PLATFORM LL1775

HINOWA**2.1.4 TECHNICAL SPECIFICATIONS**

PLATFORM CAPACITY	230 kg
PLATFORM HEIGHT (floor)	14,96 m
MAX WORKING HEIGHT	17,06 m
STANDARD BASKET DIMENSIONS	1335 x 690 x H1100 mm
HORIZONTAL EXTENSION	7,00 m
MAX HORIZONTAL OUTREACH	7,50 m
ROTATION (non-continuous)	360°
BASKET ROTATION	124° (+/- 62°)
MAX GROUND REACTION FORCE FOR EACH STABILISER	1731 daN
MAX GROUND PRESSURE FOR EACH STABILISER	2,45 daN/cm ²
NO. OF OPERATORS	2
NO. OF OPERATORS WITH OPTIONAL SINGLE-OPERATOR BASKET	1
JIB - TYPE OF ARTICULATED JOINT	89°(+0°/-89°)
MAX WORKING GRADIENT	1°/1,75%
MAX STABILISATION SLOPE	12°
TOTAL WEIGHT IN TRANSPORT CONFIGURATION	2230 kg
ENGINE	HONDA iGX440 - (12,7cv) / 3600rpm HATZ 1B40 - (10,2cv) / 3600rpm
ELECTRIC MOTOR	2,2 kw / 230V / 50Hz 1500 rpm
ELECTRICAL SYSTEM VOLTAGE	12 V
PUMPS PETROL ENGINE	double 2x4 cc
PUMPS DIESEL ENGINE	double 2x4 cc
MAX TRAVEL SPEED THERMIC ENGINE	1,8 km/h
MAX TRAVEL SPEED THERMIC ENGINE WITH OPTIONAL 2 ND SPEED	0,7 / 1,8 / 3,6 km/h
TRAVEL/STAB. SYSTEM PRESSURE	165 bar
AERIAL PART SYSTEM PRESSURE	185 bar
MAX SLOPE ALLOWED IN TRAVEL DIRECTION	15°
MAX WIND SPEED	12,5 m/s
MAX MANUAL FORCE ALLOWED	400 N

NB: Side extension is measured from the centre of the turntable to the outside edge of the basket.

2.1.4.1 TECHNICAL DATA – PETROL ENGINE

Make/Model	HONDA iGX440
Fuel/Cooling	PETROL/AIR
Power SAEJ1349	9,5 Kw (12,7cv) / 3600rpm
Max speed	3600 rpm
Maximum torque	29,8 Nm/2500 rpm (80/1269/EC)
Number of cylinders	1
Displacement	440 cm ³
Sound power level at operator's ear	88 dB
Measured sound power level	102 dB
Granted sound power level	104 dB

2.1.4.2 TECHNICAL DATA – DIESEL ENGINE

Make/Model	HATZ 1B40
Fuel/Cooling	DIESEL/AIR
Power SAEJ1349	7,5 Kw (10cv) / 3600rpm
Max speed	3600 rpm
Maximum torque	25 Nm/2000 rpm (80/1269/EC)
Number of cylinders	1
Displacement	462 cm ³
Sound power level at operator's ear	94 dB
Measured sound power level	102 dB
Granted sound power level	104 dB

2.1.4.3 HYDRAULIC SYSTEM TECHNICAL SPECIFICATIONS

Hydraulic oil tank capacity	40 litres
Pump petrol engine	double pump 2x4 cm ³
Pump diesel engine	double pump 2x4 cm ³
Hydraulic system max pressure	210 bars

For further information, see the hydraulic diagram enclosed with the manual and the paragraph on maintenance of the hydraulic components.

2.1.5 TERMINOLOGY

To make the contents of this manual easier to understand, the diagram provided below illustrates the terms used to identify the parts of the platform.

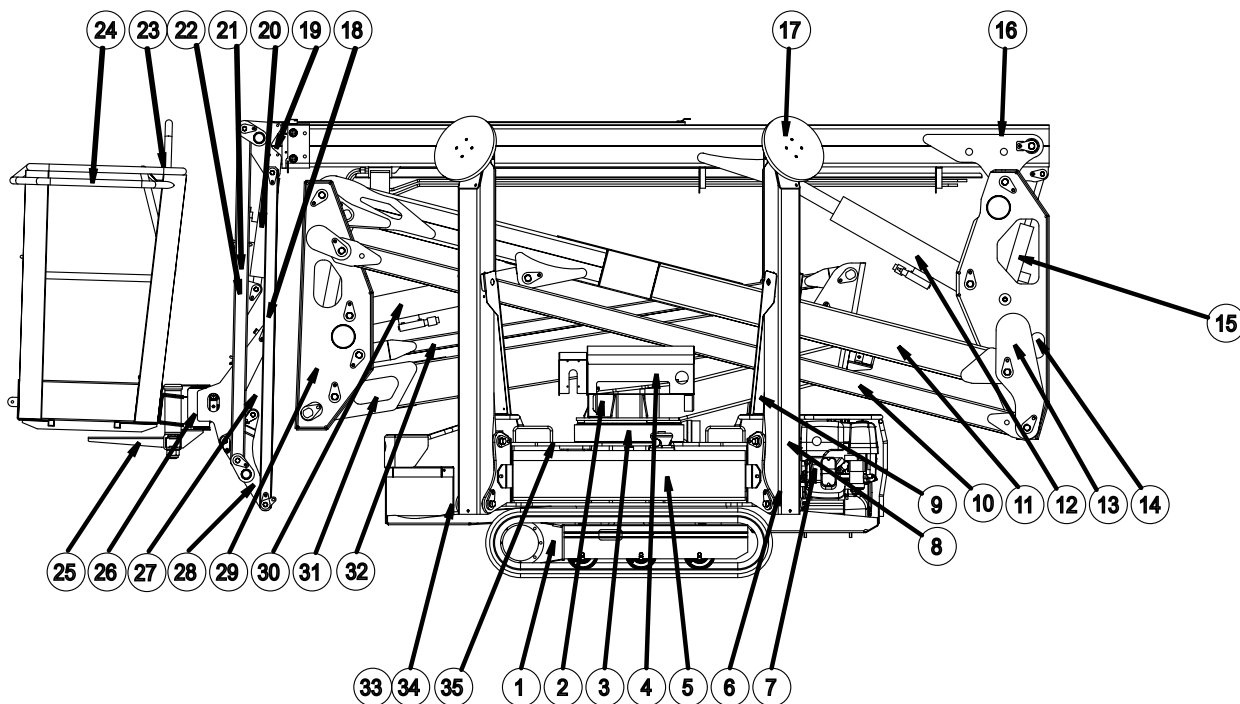

KEY

1	Tracked undercarriage	19	Extension arm
2	Revolving turret	20	Jib cylinder
3	Turntable + rotation motor	21	Right jib arm
4	Emergency controls	22	Left jib arm
5	Base+electrical component compartment+oil tank	23	Remote control for fault management
6	Double gear pump	24	Basket or cage
7	Petrol/diesel engine / Battery pack + inverter + battery charger (LITHIUM MOTOR)	25	Basket support
8	Stabiliser	26	Rotary actuator for basket rotation
9	Stabiliser cylinder	27	Basket levelling cylinder on the basket
10	Second arm tie rod	28	Jib transmission
11	Second arm	29	First-second arm transmission
12	Second-third arm cylinder	30	First-second arm cylinder
13	Second-third arm transmission	31	First arm
14	Second-third arm connecting rod	32	First arm tie rod
15	Basket levelling cylinder on the transmission	33	Electric motor
16	Third arm	34	Double gear pump
17	Stabiliser plate	35	Emergency hand pump
18	Jib tie rod		

2.2 GENERAL SAFETY STANDARDS



WARNING

The functioning of the MEWPS must be in compliance with international standards of reference (see paragraph "NORMATIVE REFERENCES" in the first pages of the manual) and national or regional standards if stricter.

The operator must read, understand and follow all the instructions and warnings, contained in this manual and on the machine, regarding the safe use of the MEWPS.



FAILURE TO COMPLY WITH THE SAFETY PRECAUTIONS LISTED IN THIS SECTION AND PROVIDED ON THE MACHINE CAN DAMAGE THE MACHINE AND CAUSE INJURY OR EVEN DEATH, AND CONSTITUTES A SERIOUS BREACH OF THE SAFETY RULES.

This section of the USER AND OPERATION MANUAL describes those procedures or dangerous situations that can cause damage/injury to objects/persons and explains what the operator must do to prevent them.

- Operators must always act professionally, complying with safety standards, making sure not to underestimate their responsibility to themselves and the surrounding objects and persons.
- **Before starting work, operators must receive complete and clear training regarding the use of the machine in standard and emergency conditions. They must examine, understand and take in all the instructions given in this user manual. They must be sure that the safety devices are in perfect working order, perform the necessary checks on the machine and be familiar with the conditions of the ground on which the machine is going to be operated and stabilised.**
- The presence of at least one specialist operator is necessary on the ground during work. This person must know how to use the machine, be aware of the contents of the USER AND OPERATION MANUAL and be able to intervene if necessary.
- It is prohibited to make modifications to the machine that could jeopardise functioning and safety, without previous written authorisation from The Constructor which is not liable for any injury or damage caused by this behaviour.

Clothing and protective equipment

Avoid wearing loose clothing, rings, watches or anything else that may get caught in moving parts.

When using the machine or performing maintenance, wear a hard hat, glasses, safety footwear, gloves and acoustic earmuffs after making sure these and all other PPE that the safety manager considers necessary based on the risk analy-



sis performed are in perfect working condition.



IMPORTANT

USE THE TYPE-APPROVED AND CERTIFIED SAFETY HARNESSSES. BEFORE WORKING AT A HEIGHT, MAKE SURE THAT THE SAFETY HARNESSSES ARE CORRECTLY FASTENED AND CONNECTED TO THE ANCHORAGE POINTS ON THE BASKET.

THE USE OF HARNESSSES IS COMPULSORY IN ACCORDANCE WITH LOCAL LEGISLATION IN EACH INDIVIDUAL COUNTRY. IN COUNTRIES WHERE THE LAW DOES NOT REQUIRE THE USE OF SUCH SAFETY SYSTEMS, THE EMPLOYER AND/OR USER IS RESPONSIBLE FOR CHOOSING THE SYSTEM TO BE USED.

Safety valves and electrical system safety components

It is prohibited to modify and/or tamper with the safety and control valves of the main hydraulic system and the adjustments of the electric plant. The Constructor is not liable for injury to persons and damage to objects or to the machine if the standard calibration of any hydraulic and electric/electronic component is tampered with.

Fire prevention

Keep the area around the motor clean, removing fragments of wood, paper and other flammable products; clean any fuel leaks as these may be a potential cause of fire.

Petrol is extremely flammable and explosive in particular conditions. Refuel in well ventilated areas and with the engine at rest.

Avoid smoking and producing sparks in the refuelling and fuel storage area.

After refuelling, make sure to put back the cap correctly. Take care to avoid touching the exhaust silencer when this is hot, i.e. with the machine running or soon after stopping the engine.



Preventing damage caused by washing the machine

Do not direct high pressure jets towards the electrical components while washing the machine. Do not use chemical detergents or petrol that would damage the plastic parts and the painting.



BEFORE WASHING THE MACHINE, ALWAYS REMEMBER TO REMOVE THE REMOTE CONTROL AND CORRECTLY CLOSE THE REMOTE CONTROL AND EQUIPMENT CONNECTION SOCKETS LOCATED ON THE MACHINE.

- **Cleaning the machine**

Always park the machine as shown in the figure in point 2.1.5.



WARNING

When washing the machine, the ignition block must be disengaged, the key removed and the emergency stop button pressed.

- **Washing the outside of the machine**

Never use flammable liquids. Adopt the above safety measures to prevent sparks due to short-circuits.

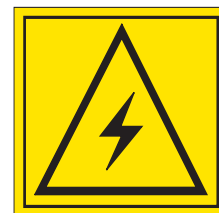

If washing the track with water cleaners, carefully protect all the important parts and above all the electrical components. Follow the instructions provided by the manufacturer of the detergent.



Clean the machine using water-soluble detergents.



WARNING

The more the elevating platform is cleaned, the more it will need to be greased (see par. 7.3 Grease points).



WARNING

Do not wet the electric motors and the other electrical components directly. Do not aim the spray directly onto adhesive labels and rating plates.

- **Cleaning the electrical system**



WARNING

Never clean the inverter or the electric motor with water, as this may cause damage to the electrical system.





IMPORTANT

Only use dry detergents, in accordance with the manufacturer's instructions. Never remove covers, guards and the like.

- Clean the electrical system using a dry, non-metallic brush and low pressure air.

• **After cleaning**

Dry the machine carefully before starting it again (for example using compressed air).



WARNING

If, despite all the precautions, moisture has penetrated into the electric motor or other parts of the electric system, these must be dried using compressed air to avoid the risk of short-circuits.

Preventing damage that may be caused by the machine during work

When the machine has been stabilised and work has started, never enter its operating area. Always operate the controls slowly and smoothly and avoid reversing the movements suddenly.

When operating outside of the basket, ALWAYS keep a MINIMUM distance of 1 METRE from the machine.

2.3 SAFETY WARNINGS

2.3.1 GENERALITIES

To avoid accidents, before starting work and before performing any maintenance operations, it is necessary to read, understand and follow all the precautions and warnings contained in this manual. The user/operator of the machine must decline all responsibility for operation until having read this manual and fully understood how to use the machine under the supervision of an expert and qualified operator.

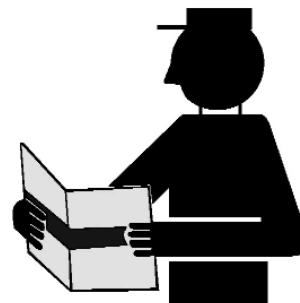

Carefully read all the safety messages provided in this manual and the safety signs on the machine.

Keep the safety signs in good condition and replace them if they are damaged.

Make sure that any new components on the machine are provided with the correct safety signs.

2.3.2 NOISE AND VIBRATIONS

The HINOWA platforms with electric motor have been tested according to the parameters of European directive 2000/14 EC, with the guaranteed sound power level measurement shown on the machine's EC declaration of conformity.

When operating the aerial part of the machine, this value is reduced even further as the basket moves away from the main source of noise.

The vibrations transmitted to the operator from the controls and directly from the floor of the basket are lower than the maximum allowed limits.

SELF-PROPELLED TRACKED PLATFORM LL1775

HINOWA

2.3.3 PICTOGRAMS POSITIONED ON THE MACHINE

Here we report the positions of the various boards with pictograms on the machine.

	KIT ADESIVI - LL17.75 SET OF DECALS - LL17.75 KIT COLLANTS - LL17.75	cod. 17198600 Ed. 07/11/2012 Tav 01
KIT ADESIVI - LL17.75 SET OF DECALS - LL17.75 KIT COLLANTS - LL17.75	AUFKLEBERSATZ - LL17.75 KIT ADHESIVOS - LL17.75 ADHESIEKIT - LL17.75	

SELF-PROPELLED TRACKED PLATFORM LL1775

HINOWA

	KIT ADESIVI - LL17.75	AUFKLEBERSATZ - LL17.75	cod. 17198600
	SET OF DECALS - LL17.75	KIT ADHESIVOS - LL17.75	
	KIT COLLANTS - LL17.75	ADHESIEKIT - LL17.75	
			Ed. 07/11/2012 Tav 02

SELF-PROPELLED TRACKED PLATFORM LL1775**HINOWA**

POS.	CODE	Q.ty
1	6555500	1
2	6555600	1
3	6555700	1
4	6555800	1
5	6041200	4
6	6506700	7
7	6068700	1
8	6924300	1
9	6040400	1
10	6040500	2
11	6040900	5
12	6041300	13
13	6041000	4
14	6044000	8
15	6086600	2
16	1704277	2
17	6136900	1
18	6396200	2
19	6311200	4
20	7058800	2
21	6040800	4
22	6704400	2
23	6919400	1
24	6665700	3
25	6086000	1
26	6085900	1
27	6706500	1
28	6998800	1
29	7242000	1
30	6227100	1
31	6226900	1
32	6164700	1
33	6165000	1
34	6060000	1
35	6227200	1

POS.	CODE	Q.ty
36	6041600	1
36	6043900	1
37	6056300	1
38	6164600	1
39	6232100	1
40	7240300	1
41	7198800	4
42	07034200	2
43	7199000	1
44	1608710001	1
45	1608710002	1
46	7199100	1
47	06254800	1

SELF-PROPELLED TRACKED PLATFORM LL1775**HINOWA**

LANGUAGE STICKERS

POS.	CODE	Q.ty
	171986IT	
L1	6555300	1
L2	6561200	5
L3	6448200	2
L4	6448100	2
L5	07319100	1
	171986GB	
L1	6562600	1
L2	6561200	5
L2	6042400	5
L2	6257300	5
L3	6462700	2
L4	6462100	2
L5	073191GB	1
	171986FR	
L1	6562700	1
L2	6561200	5
L3	6462800	2
L4	6462200	2
L5	073191FR	1

POS.	CODE	Q.ty
	171986DE	
L1	6562800	1
L2	6561200	5
L3	6462900	2
L4	6462300	2
L5	073191DE	1
	171986ES	
L1	6562900	1
L2	6561200	5
L3	6463000	2
L4	6462400	2
L5	073191ES	1
	171986NL	
L1	6563000	1
L2	6561200	5
L3	6463100	2
L4	6462500	2
L5	073191NL	1

POS.	CODE	Q.ty
	171986PT	
L1	6563100	1
L2	6561200	5
L3	6463200	2
L4	6462600	2
L5	073191PT	1

SELF-PROPELLED TRACKED PLATFORM LL1775

HINOWA



7



8

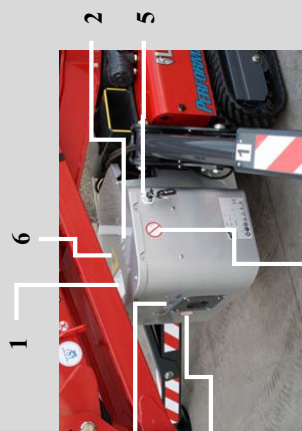

9

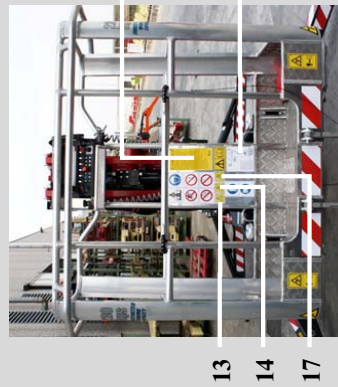

4



7

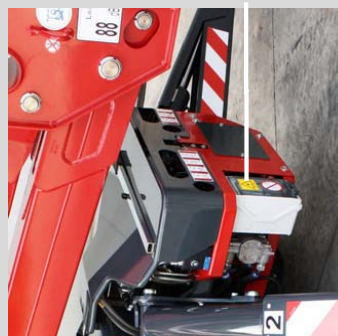

5



11

7



13

14

17

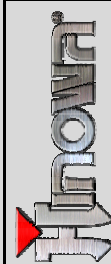

KIT ADESIVI - LL1775SLI

SET OF DECALS - LL1775SLI

KIT COLLANTS - LL1775SLI

AUFKLEBERSATZ - LL1775SLI

KIT ADHESIVOS - LL1775SLI

ADHESIEKIT - LL1775SLI

cod. 16924900

Ed. 08/11/2012 Tav 01

SELF-PROPELLED TRACKED PLATFORM LL1775

HINOWA

				<p>cod. 16924900</p>
	<p>AUFKLEBERSATZ - LL17753SLI</p>		<p>KIT ADHESIVOS - LL17753SLI</p>	<p>ADHESIEKIT - LL17753SLI</p>
	<p>KIT ADESIVI - LL17753SLI</p>	<p>SET OF DECALS - LL17753SLI</p>	<p>Ed. 08/11/2012</p>	<p>Tav 02</p>
				

SELF-PROPELLED TRACKED PLATFORM LL1775**HINOWA**

Pos	Code	qty
1		
2	06931100	2
3	07206100	1
4	06506700	3
5	06506400	1
6	0693100	1
7		
8	06922200	2
9	06520600	2
15	07243100	1
19	07264700	1

LANGUAGE STICKERS

Pos	Code	qty
	169249IT	
1	06804900	1
7	06561200	5
10	06448100	2
11	06448200	2
12	06555300	1
13	06909000	1
14	06908900	1
17	06909100	2

Pos	Code	qty
	169249GB	
1	06924800	1
7	06561200	5
7	06042400	5
7	06257300	5
10	06462100	2
11	06462700	2
12	06562600	1
13	06924600	1
14	06924500	1
17	06924700	2

Pos	Code	qty
	169249FR	
1	06940700	1
7	06561200	5
10	06462200	2
11	06462800	2
12	06562700	1
13	06940300	1
14	06939500	1
17	06939900	2

Pos	Code	qty
	169249DE	
1	06930200	1
7	06561200	5
10	06462300	2
11	06462900	2
12	06562800	1
13	06930400	1
14	06930300	1
17	06930500	2

SELF-PROPELLED TRACKED PLATFORM LL1775

HINOWA

Pos	Code	qty
	169249ES	
1	06940800	1
7	06561200	5
10	06462400	2
11	06463000	2
12	06562900	1
13	06940400	1
14	06939600	1
17	06940000	2

Pos	Code	qty
	169249NL	
1	06940900	1
7	06561200	5
10	06462500	2
11	06463100	2
12	06563000	1
13	06940500	1
14	06939700	1
17	06940100	2

Pos	Code	qty
	169249PT	
1	06941000	1
7	06561200	5
10	06462600	2
11	06463200	2
12	06563100	1
13	06940600	1
14	06939800	1
17	06940200	2





Pos	Code	qty
	169249SW	
1	07259500	1
7	06561200	5
10	07137400	2
11	07137500	2
12	07137300	1
13	07259600	1
14	07259700	1
17	07259800	2

Pos	Code	qty
	169249DA	
1	07259900	1
7	06561200	5
10	07137900	2
11	07138000	2
12	07138100	1
13	07260000	1
14	07260100	1
17	07260200	2

Pos	Code	qty
	169249NO	
1	07260300	1
7	06561200	5
10	07161900	2
11	07161800	2
12	07162000	1
13	07260400	1
14	07260500	1
17	07260600	2

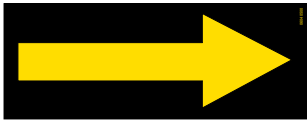

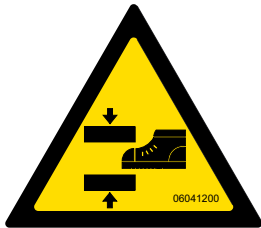
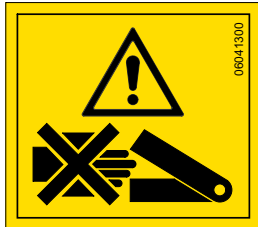

SELF-PROPELLED TRACKED PLATFORM LL1775

HINOWA

Code	Name	Description	Identikit
06040300	WARNING KEEP SAFE DISTANCE		
06040500	SENSE OF MOVING UNDERCARRIAGE	DEFINED AS THE DIRECTION FORWARD	
06040800	CRUSHING HAZARD PERSON		
06040900	OBLIGATION TO READ THE MANUAL BEFORE USE OF MACHINE		
06041000	FIXING POINT FOR TRANSPORT	INDICATES CORRECT FIXING POINT FOR TRANSPORT OF THE MACHINE	
06041200	CRUSHING HAZARD FEET	INDICATES AREAS WHERE THERE IS A DANGER OF CRUSHING LOWER LIMBS FOR THE OPERATOR	
06041300	CRUSHING HAZARD PERSON	INDICATES AREAS WHERE THERE IS A DANGER OF CRUSHING UPPER LIMBS FOR THE OPERATOR	

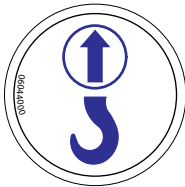

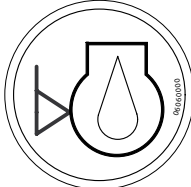
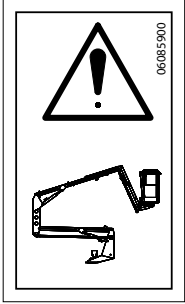
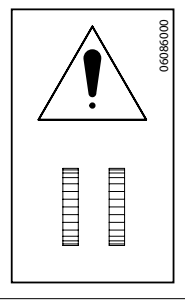
SELF-PROPELLED TRACKED PLATFORM LL1775

HINOWA

Code	Name	Description	Identikit
06044000	LIFTING POINT	INDICATES CORRECT LIFTING POINTS FOR LIFT THE MACHINE	
06056300	DANGER HIGHT TEMPERATURE		
06060000	ENGINE OIL LEVEL		
06085900	EMERGENCY DEVI-CE FOR AERIAL PART	DEVICE THAT ALLOWS TO EXCLUDE THE SAFETY OF THE AERIAL PART IN CASE OF EMERGENCY OPE-RATIONS	
06086000	EMERGENCY DEVI-CE FOR UNDERCAR-RIAGE	DEVICE THAT ALLOWS TO EXCLUDE THE SAFETY OF THE UNDERCARRIAGE IN CASE OF EMERGENCY OPERATIONS	
06086600	WARNING KEEP SAFE DISTANCE AND CRUSHING HAZARD PERSON		

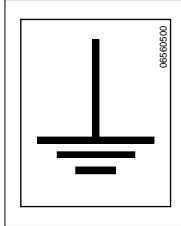
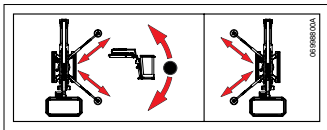

SELF-PROPELLED TRACKED PLATFORM LL1775

HINOWA

Code	Name	Description	Identikit
06165000	HYDRAULIC OIL LEVEL		
1701499	FORBIDDEN LIFTING POINT		
06506700	DO NOT WASH WITH WATER		
06560500	GROUNDING		
06998800	HAND PUMP LEGEND	QUICK INSTRUCTIONS FOR USING THE EMERGENCY HAND PUMP	
06924300	BE CAREFULL AT WORK	USING SAFETY HARNESSSES, USE PROTECTIVE EQUIPMENT (HELMET), PROHIBITION OF WELD ON THE MACHINE, PROHIBITION OF USE SYSTEMS TO INCREASE THE AREA OF WORK INSIDE THE BASKET, PROHIBITION OF WORKING IN THE VICINITY OF VOLTAGE ELECTRIC, PROHIBITION OF USE OF THE PLATFORM FOR RAISING LOADS	



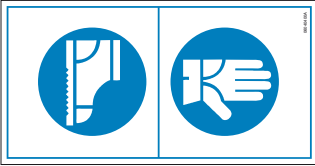
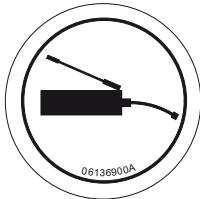

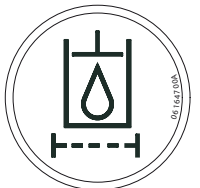
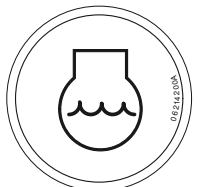
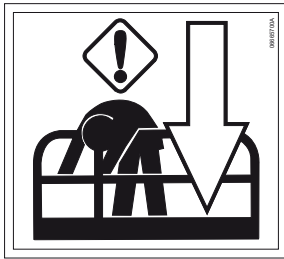

SELF-PROPELLED TRACKED PLATFORM LL1775

HINOWA

Code	Name	Description	Identikit
06040400	USE PPE AT ALL TIMES WHEN WORKING		
06136900	COMPLY WITH THE GREASING INTERVALS AT THE SPECIFIED POINTS		
06164600	AIR FILTER		
06164700	HYDRAULIC OIL FILTER		
06214200	ENGINE REFRIGERANT LEVEL		
06665700	POSITION OF EMERGENCY CONTROLS TO BE OPERATED FROM THE GROUND		



SELF-PROPELLED TRACKED PLATFORM LL1775

HINOWA

Code	Name	Description	Identikit
06924800	BATTERY PACK WARNINGS		 <p>WARNING! <small>Operating and handling the battery pack are dangerous operations. Not respecting this prohibition causes the guaranteed decay.</small> DON'T OPEN THE BATTERY PACK. - Only qualified FAAM Group Service is authorized to handle and replace the pack and the fuse. - Operating temperature range: 0°C to 40°C. Don't leave for a long time in sunny and ventilated place. - External operating recharging temperature: 0° to 40°. Recharge only in dry place. - Always control the recharging cycle. - Don't leave the battery pack discharged. Recharge the battery any time possible, even if the battery is not completely discharged.</p>
	CORROSIVE LIQUID	Presence of highly corrosive liquid, dangerous to the body and eyes.	
	HIGH VOLTAGE	Presence of high voltage with danger of electric shock.	
	DANGER OF EXPLOSION	Formation of potentially explosive mixture inside the battery.	
	NO NAKED FLAMES	Do not smoke or use naked flames when recharging and near the vehicle. Risk of explosion.	
	RECYCLING	It is highly recommended to comply with legislative and environmental standards as regards the demolition, reuse, recycling and recovery of materials.	
	READING REQUIRED	It is compulsory to read everything described in the manual.	

SELF-PROPELLED TRACKED PLATFORM LL1775

HINOWA

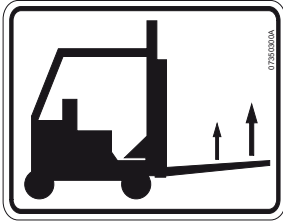
Code	Name	Description	Identikit
06924800	GLASSES REQUIRED	It is compulsory to wear protective glasses.	
	GLOVES REQUIRED	HEAT RESISTANT GLOVES: Work requiring contact with high temperature components, in particular during maintenance operations. OIL PROOF GLOVES: Work requiring contact with lubricating oils and greases and hydraulic oil.	
1704277	ANCHOR POSITION IN BASKET	INDICATES THE POSITION OF THE ANCHOR HOOKS TO WHICH FASTEN THE OPERATOR'S SAFETY SLING	
07350300	LIFTING POINTS WITH FORKLIFT	INDICATES THE LIFTING POINTS WITH FORKLIFT	



REPLACE STICKERS AND PLATES IF THERE IS ANY SIGN OF WEAR.



FAILURE TO HEED ANY WARNINGS DUE TO A SAFETY STICKER BEING DAMAGED, LOST OR IGNORED MAY CAUSE SERIOUS ACCIDENTS.

3 SAFETY DEVICES

The information given below concerning the safety devices are provided to the user in order to allow him/her to understand the machine behaviour and possible work sequences; moreover, in this way it is possible to identify any breakdowns with greater precision and to supply more detailed information to the after-sales service for quicker, less expensive interventions.



The machine is fitted with safety devices used to prevent dangerous situations for the operator. It is important that before starting any operation, the operator checks the perfect working order of these devices.



The non-functioning of a safety device, whether caused by a fault or tampering, can cause serious damage to the machine and consequently put the operator's life at risk. The Constructor has designed the machine and safety devices in order to guarantee the maximum to its customers, however the devices must be checked periodically according to that described in this manual and they must never be tampered with.

The service function on the remote control can be used as an aid for checking electric safety devices.



Never intervene on the safety devices. If they are tampered with, the manufacturer declines all liability regarding any accidents that may be due to such tampering.



It is prohibited to tamper with the lead sealing or setting of the maximum pressure valves and the adjustments of the electrical components. If they are tampered with the manufacturer declines all liability for any accidents that may be due to such tampering.



The Constructor is not liable for any damage/injury caused by the machine to objects and/or persons due to failure to comply of that stated above.

3.1 BATTERY CUTOFF SWITCH



THERMIC MOTOR

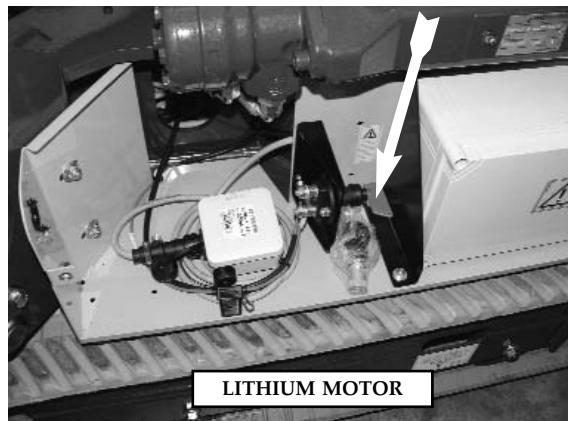

LITHIUM MOTOR

This device, located on the left side of the electrical components compartment, is used to isolate the machine's electrical circuit, stopping any movements. It is well-visible and easily accessed without using tools. It only needs to be activated for prolonged machine downtime or maintenance operations.

Turning the key clockwise closes the machine's electrical circuit, while turning it anticlockwise isolates the machine's electrical circuit and the key can be removed.



IMPORTANT

BEFORE DISCONNECTING THE BATTERY BY MEANS OF THIS DEVICE, MAKE SURE THAT THE ENGINE KEY IS IN POSITION "OFF" AND THE REMOTE CONTROL AND ELECTRONIC BOARD ARE OFF.

3.2 DISTRIBUTOR PRESSURE RELIEF VALVES

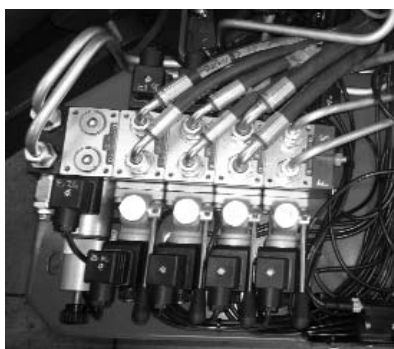

All platform distributors have an over-pressure valve that limits the pressure that can be reached inside the calibration pressure plant of the valve itself.

These valves are calibrated in the platform inspection phase by qualified staff working and must not be tampered with for any reason.

3.3 CYLINDER STOP VALVES



The stabiliser cylinders have a double stop valve which in case of system breakdown or hose breakage stops the cylinder preventing dangerous platform instability situations.

All cylinders that move the aerial part of the platform structure are fitted with a stop valve which in case of system breakdown or hose breakage stops the cylinder preventing the basket from falling due to gravity.

These valves are calibrated in the platform inspection phase by qualified staff working and must not be tampered with for any reason.

3.4 ALIGNMENT PHOTOCELLS ON THE AERIAL PART OF THE STRUCTURE AND THE BASE OF THE MACHINE



The platform has two safety photocells that ensure that the aerial part of the machine is completely lowered and aligned with the base and that the telescopic arm is completely retracted.

When these conditions are not met, a signal is sent that disables the movement of the stabilisers.

3.5 STABILISER POSITION MICROSWITCHES, STANDARD VERSION



The position of the stabilisers and their contact with the ground are detected by 4 microswitches positioned near the stabiliser cylinder rod fastening pin. The microswitches fixed to the stabiliser must be released when the stabiliser rests on the ground.

Check the correct operation of the microswitches every day.

3.6 JIB POSITION MICROSWITCH

The position of the jib arm is detected by a microswitch that is secured to the jib arm itself.

The microswitch must be released when the jib arm is closed.

Check the condition and correct operation of the JIB microswitch every day.



3.7 BASKET LOAD SENSOR

The load sensor on the basket is made up of a basket support with two shafts that only allow the vertical movement of the basket. The basket support is supplied by the load cell itself. Two strain gauges are positioned inside the sensor positioned under the basket and convert the relative weight inside the basket into an electrical signal. The electrical signal is then sent to the electronic board, which processes it and identifies any dangerous conditions.



The remote control display always shows the maximum load allowed according to the work mode.

When the maximum allowable load is reached, an icon appears on the remote control display, a sound signal is emitted and all platform movements are disabled.

To restore platform operation the excess weight must be removed in order to return below the maximum allowable weight (see paragraph on the display).



WARNING

The Constructor recommends that maximum attention is paid to the conditions of all safety components and in particular of the system that makes up the basket load sensor; always check correct operation whenever objects are struck with the basket or if performing operations that may damage the system (e.g. pruning, painting etc.).

COVER

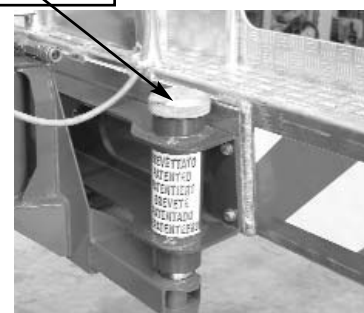

DANGER

Before any elevating manoeuvre, always make sure that the two closing covers on the vertical pins are completely screwed in.

3.8 CONTROL PROTECTION

A protection structure is provided to protect the remote control against the accidental fall of objects from above and involuntary activation by the operator.

Always make sure that this protection structure is intact before using the machine.



3.9 SPIRIT LEVEL

The spirit level is positioned on the turret and it is readily visible from the basket and from the ground. The spirit level must be used to make sure that during the platform levelling phase the maximum allowable gradient of 1° is complied with. This condition is met when the air bubble is inside the green area.



A second electronic spirit level contained in the control board makes sure that this condition is effectively satisfied and checks the power supply to the controls for the aerial part.

Always check the correct levelling of the machine after every self-levelling operation.



Approximate levelling outside of the limits set by the manufacturer is very dangerous and can affect the stability of the platform, which represents a risk, even deadly, for the operator and other persons working on the machine and near it.



Never intervene on the spirit level adjustments; this device is calibrated by the Constructor during the inspection before sale. Only technicians authorised by the Constructor and in possession of suitable tools can intervene on the spirit level.

3.10 PIN LOCKING BOLTS AND NUTS

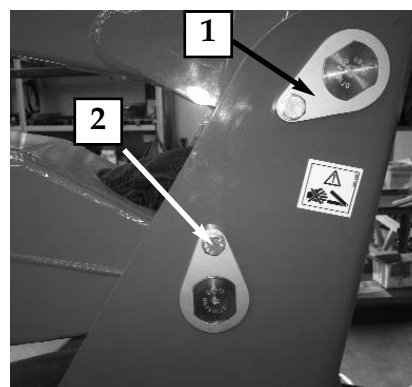
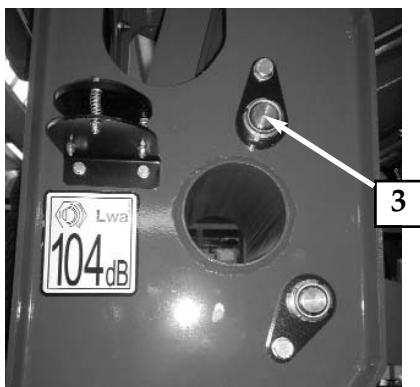

All the pins used on the HINOWA platform were treated against wear and are fitted with flanges (1) to prevent them from rotating inside their seat. Some pins have bolts to stop rotation (2) while others pins have a joint in the structure of the machine.

The pins in the most delicate positions are threaded at the ends and are fitted with self-locking nuts (3) or self-locking threaded ring nuts to prevent the structure from subsiding. Check the correct tightness of all the pin locking devices according to the intervals indicated by the manufacturer of the machine.



Never loosen the pin locking devices and periodically check they are correctly tightened. A pin that comes off its housing, even partially, may cause unexpected and uncontrollable movements and even cause the machine to lose stability and/or the basket to fall.

3.11 SAFETY DEVICE ELECTRONIC CONTROL BOARD

The HINOWA platform has an electronic control board (see photo) that enables the power supply to the ON-OFF proportional coils after verification of the safety conditions by the sensors positioned on the machine.

The control procedure on the electronic board may be bypassed using the key selector switch with spring return: “safety device bypass key”.

The electronic board records every bypass action carried out by the operator on the safety devices, filing them by date, time and lapse of time during which the operator held the “safety device bypass key” in position.

The board is also provided with an event record that stores all the operations performed on the machine for a variable period of time.



4 INSTRUMENTS AND CONTROLS

Below is a description of all the controls and indicators present on the platform; each device has a sticker that briefly describes its function applied nearby, often containing symbols that are used to ensure quick and clear understanding. Before using the platform, the following descriptions must be read in order to gain in-depth knowledge of the functions of each device and to be aware of any suggestions provided by the manufacturer.

Before starting to use the platform, the operator must read and perfectly understand all the instructions contained in this manual.

4.1 REMOTE CONTROL

The remote control contains most of the controls required for normal operation of the machine.

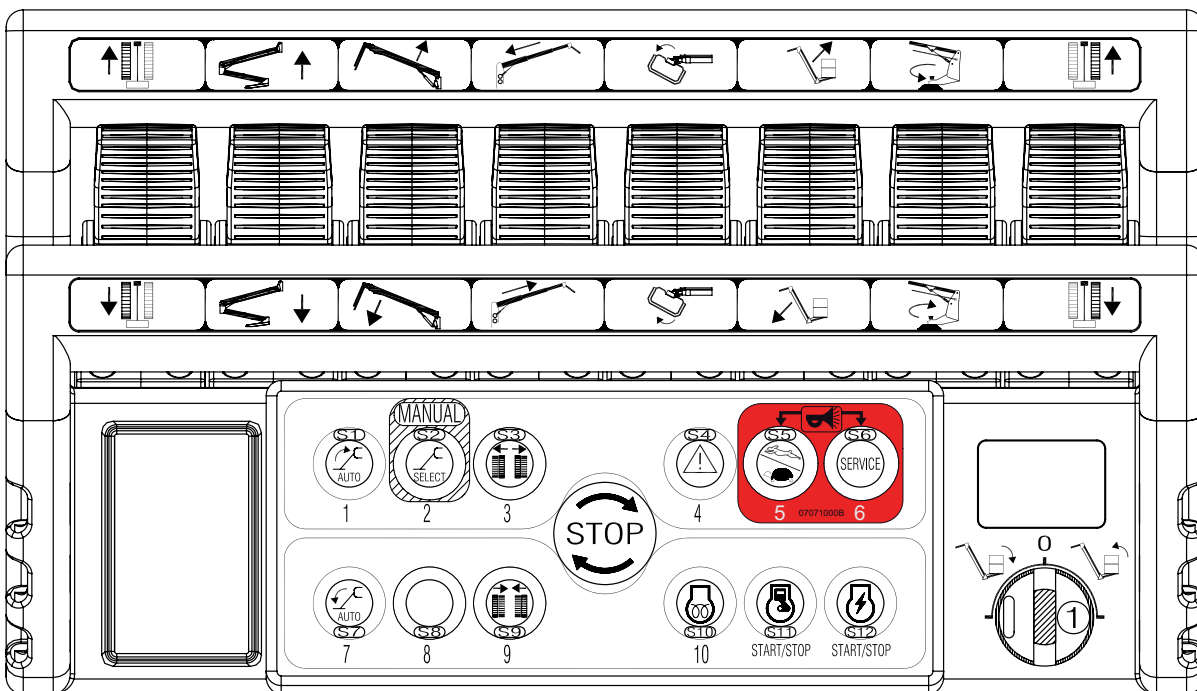

The remote control is made up of buttons, joysticks, a key selector switch and a display. The remote control continuously exchanges data with the machine's main board, which in turn transmits the information to be shown on the display.

4.1.1 DISPLAY

The display is used to view the status of the machine and the operating information necessary or useful for the operator.

When the machine's main control board is powered via the engine key, the information to be shown on the display is sent to the remote control.

This operation has a variable duration. Normally a few seconds are sufficient, however the following screen may appear on the display:

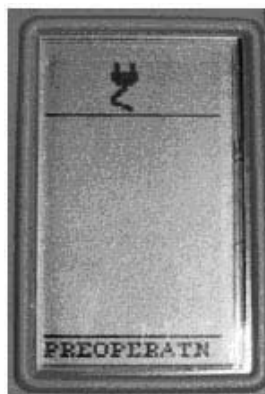

In this case about 5-10 minutes are needed to send all the information from the main board to the remote control. The machine cannot work during this period.

Do not stop the machine or operate it during this period.

4.1.1.1 DISPLAY MAIN SCREEN

When the machine is started, the main screen is displayed, giving a general overview of the machine status. For the sake of simplicity and clarity a layout is provided with 8 icon display positions.

Example of the main screen:

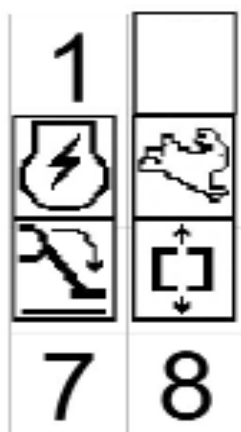

Icon position diagram:

1	2
3	4
5	6
7	8

POSITION 3:

Position 3 displays the engine/motor selection and the engine status.



Petrol/diesel engine



Electric motor

An X on the icon indicates that the engine/motor is off, no X indicates that it is on.

POSITION 4:

Position 4 displays the selected speed or the reduced speed for the Lithium:



SLOW

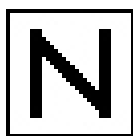

NORMAL



FAST

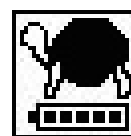

REDUCED

POSITION 5:

Position 5 displays the icon confirming that overhead movements are enabled.

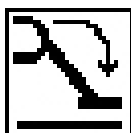

This icon means that all conditions for using the overhead movements have been checked and the aerial part can be lifted. No icon on means that the aerial part cannot be lifted. In place of this icon, the basket overload icon may be shown.

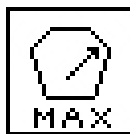

When the load sensor measures a load exceeding the allowed work load - 230 kg - the main screen disappears for three seconds, replaced by the overload error display, the audible warning is activated, then the overload icon appears in position 5 in place of the icon enabling the overhead movements.

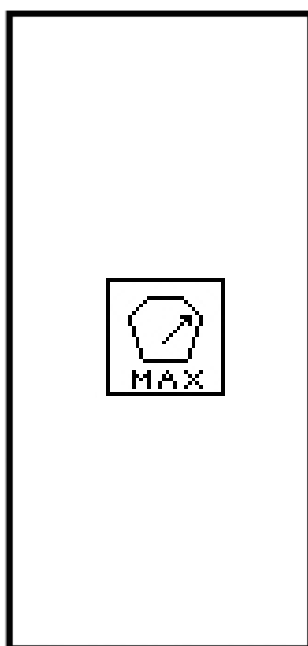

OVERLOAD ERROR DISPLAY

POSITION 6:

Position 6 displays the icon confirming that track movements (stabilisers, tracks, track extension) are enabled.

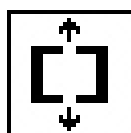

This icon means that all conditions for operating the track movements have been checked. No icon on means the stabilisers cannot be used and the track cannot be extended. The machine, however, can travel even when the icon is off, as long as all 4 stabilisers are lifted from the ground.

POSITION 7:

Position 7 is used for functional signals:

Emergency STOP pressed

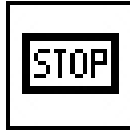

Signals that one of the emergency stop buttons on the machine has not been released.

BATTERY VOLTAGE BELOW MINIMUM LIMIT.

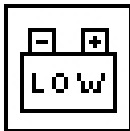

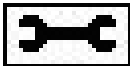

Indicates that the battery charge level is below the minimum limit allowed. If this message appears, it is advisable to recharge the battery, either by keeping the diesel or petrol engine on, or by connecting to the network.



Signals an error in the battery management system of Lithium version.

In this position also other functional signals can be displayed that are useful for machine diagnostics.

	<p>The angular position control does not work correctly</p>
	<p>The machine has a CANBUS line connection fault.</p>
	<p>A faulty or incorrect electronic board (card) has been installed, or alternatively an incorrect software version has been loaded.</p>

POSITION 8:

Position 8 displays the battery charge status or the icon indicating the battery is being recharged in the Lithium version.



Position 8 is used to show the selection of the emergency descent operation from the basket with solenoid valves on the cylinders.

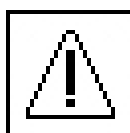

In addition to the main screen described above, there are other functional displays that will be described successively.

4.2.1 JOYSTICKS

Using the joysticks the operator selects the movement to be performed, the direction and the speed. The direction of the joystick determines the direction of the movement. The degree of movement of the joystick determines the speed. The more the joystick is moved away from the central neutral position, the faster the movements obtained.

Starting from the left in the figure shown below, the joysticks are numbered from 1 to 8. The following table shows the movement controlled and its direction depending on the joystick shifting direction.

SELF-PROPELLED TRACKED PLATFORM LL1775

HINOWA

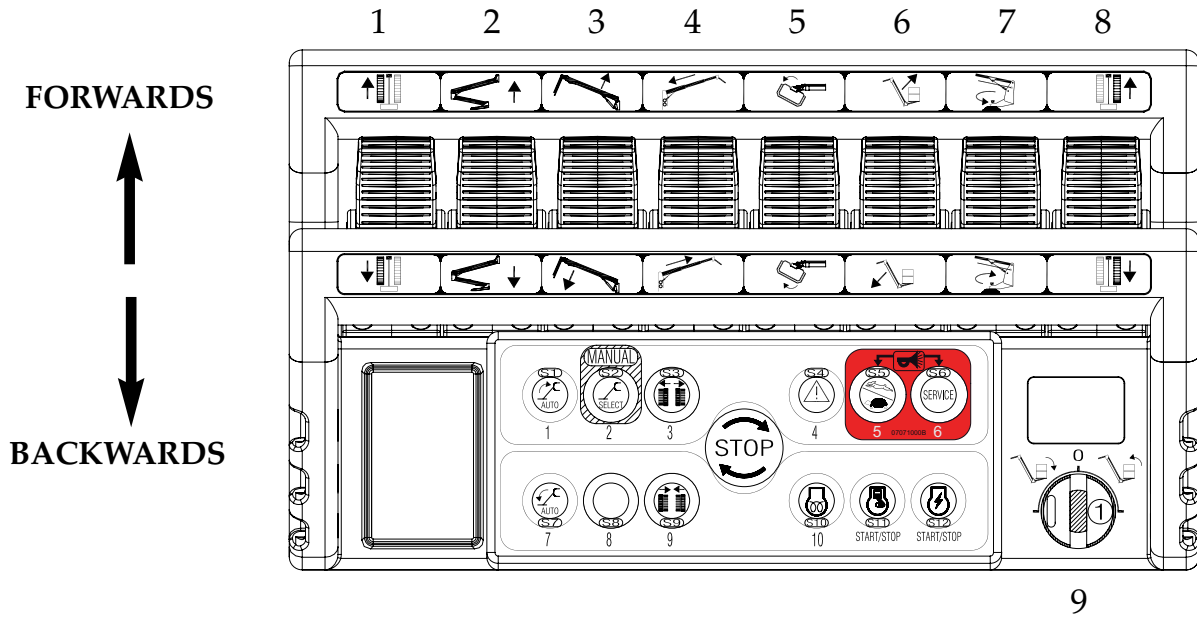

JOYSTICK	JOYSTICK SHIFTING DIRECTION	MOVEMENT CONTROLLED
		AERIAL MOVEMENTS ENABLED 
1	FORWARDS	LEFT TRACK FORWARDS
	BACKWARDS	LEFT TRACK BACKWARDS
2	FORWARDS	1st-2nd ARM UP
	BACKWARDS	1st-2nd ARM DOWN
3	FORWARDS	3rd ARM UP
	BACKWARDS	3rd ARM DOWN
4	FORWARDS	EXTENSION ARM IN
	BACKWARDS	EXTENSION ARM OUT
5	FORWARDS	BASKET ANTICLOCKWISE ROTATION
	BACKWARDS	BASKET CLOCKWISE ROTATION

6	FORWARDS	JIB OPENING
	BACKWARDS	JIB FOLDING
7	FORWARDS	ANTICLOCKWISE ROTATION
	BACKWARDS	CLOCKWISE ROTATION
8	FORWARDS	RIGHT TRACK FORWARDS
	BACKWARDS	RIGHT TRACK BACKWARDS
9	R	CLOSE BASKET LEVELLING
	L	OPEN BASKET LEVELLING

4.1.3 PUSH BUTTONS

The buttons have a dual function: they can be used to select machine functions or as numerical keys in the service submenus.

They in fact feature an icon that represents their meaning and a number for use as a numerical keypad.

An emergency STOP button is also available which, when pressed, stops the motor and brings the machine to a standstill.

The pressed position of the emergency STOP button is represented on the display in position 7.

To make the machine operational again, the button must be turned and released.

For the description of the individual functions, see paragraph 6 Using the machine.

BUTTON 1:



Used to automatically raise the stabilisers.

BUTTON 2:



Enters the menu for the manual movements of the individual stabilisers.

BUTTONS 3-9:

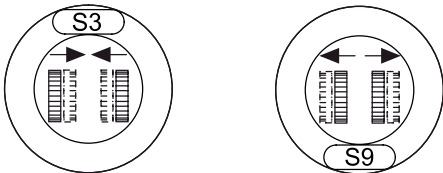

Used to extend and narrow the tracked undercarriage.

BUTTON 4

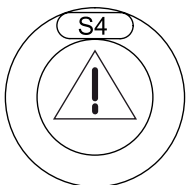

Used to enable control of the emergency descent from the basket. Confirmation that the operation is enabled is displayed on the screen in position 8.

BUTTON 5:

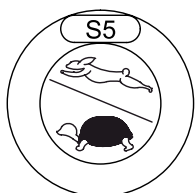

Used to select the travel speed and the engine/motor speed.

There are three speeds available:

- SLOW: engine at 1,500 rpm for the operation of the aerial part, at 2,200 rpm for the operation of the carriage. Minimum possible speed for the tracks.
- NORMAL: variable rpm according to the selected movement. Travel motors always with maximum displacement, therefore medium travel speed
- FAST: variable rpm according to the selected movement. Travel motors in automatic displacement variation mode, therefore maximum travel speed.

The three speeds are selected by pressing button 5 in sequence, with a cyclical routine. The selected speed is displayed on the screen in position 4.

BUTTON 6:

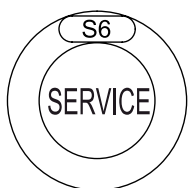

Enters the auto service menu (see paragraph 9 Remote control service menu).

BUTTON 7:

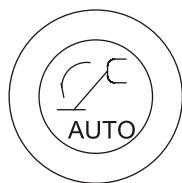

Used to automatically lower the stabilisers.

BUTTON 10 (ONLY PETROL VERSION):



Allows the preheating of the petrol engine. One pressure on the button sets the engine at 2200 rpm for 20 seconds, in order to heat the engine and improve the initial phases of use.

BUTTON 11:



Allows the engine to be switched on/off. If the button is pressed with the engine on, this will be stopped.

BUTTON 12:



Allows the electric motor to be switched on/off. If the button is pressed with the engine on, this will be stopped.

If the start buttons are pressed with an emergency STOP button pressed, starting will be impossible.

This condition is indicated by the icon STOP in position 7.

If the operator attempts to start one of the two motors while the other is already running, starting will be impossible and the icon showing the motor already on will appear at the centre of the screen.

Note:

Buttons 5 and 6 when pressed simultaneously also activate the horn (**optional**).

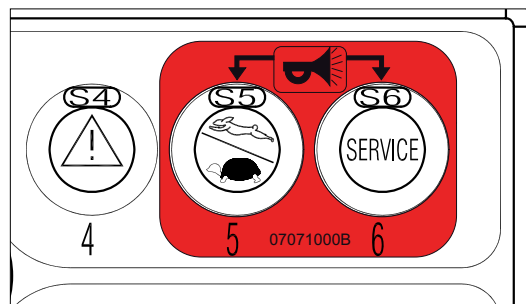

4.2 FOOTSWITCH (OPTIONAL)

Inside of the basket is fitted a footswitch device that must be pushed to allow the movement of the machine from the basket. If you try to move the machine without the footswitch pushed the movement will be prohibited and a message on the display will appear informing that it is necessary push the pedal to work. If you have not made moves to 7 seconds after pressing the pedal this must be release and pressed again to resume work.

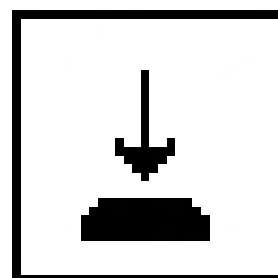
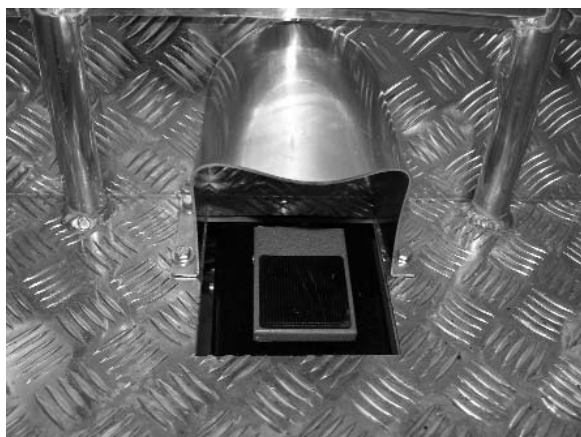

4.3 CONTROL POSITIONS

See paragraph 2.1.1 *Control position*.

5 EMERGENCY DEVICES

The following information concerning the emergency devices is provided to help understand the behaviour of the machine and the possible work sequences; moreover, the devices can thus be identified more clearly and quicker action can be taken if emergencies occur.



It is important that before starting any operation the operator checks the perfect working order of the emergency devices.

5.1 EMERGENCY STOP BUTTON



ON TRACK



ON REMOTE CONTROL

Allows immediate shutdown of all machine functions in emergency conditions.

The machine is provided with two emergency stop devices: the first is located on the carriage just above the turntable, the second on the remote control. Once the device has been activated, the button must be turned and released to allow the machine to operate again.

Selection of the emergency stop is indicated on the remote control display.



IMPORTANT

It is strongly recommended to comply with the rule whereby the platform must not be operated without personnel available on the ground. Indeed, accidental operation (e.g. due to a falling branch) or voluntary operation of the emergency button by unauthorised persons on the ground would put the occupants of the basket in the unpleasant situation of not being able to perform any movements, except descent using the emergency descent devices.

5.2 HAND PUMP

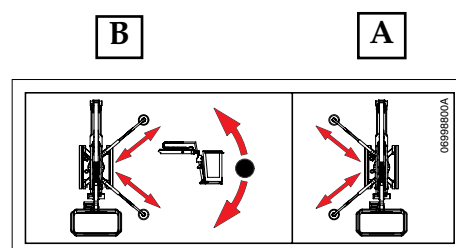
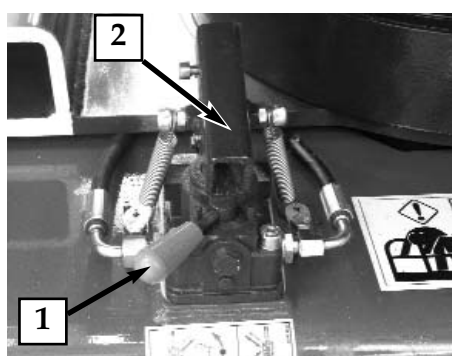

The hand pump (2) is used to pressurise oil for emergency movements made necessary by any breakdown of the main hydraulic system.

The hand pump has a manual switch (1) used to select whether to control the two left stabilisers (Position A) or to control the two right stabilisers and the aerial part of the structure (Position B).

5.3 SOLENOID VALVES FOR EMERGENCY DESCENT

The cylinders of the first-second arm, of the third arm and the jib have a solenoid valve for emergency descent (1). Activating the emergency descent button on the remote control energises these solenoid valves, which allow the descent of the aerial part of the structure due to gravity.

The use of this emergency device depends on the platform's electrical system being powered.

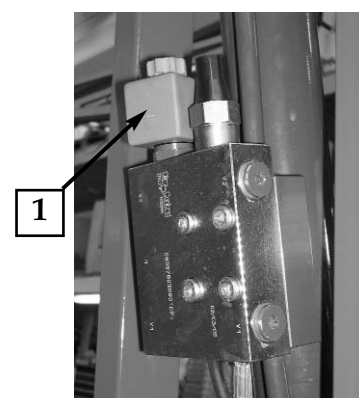

5.4 SAFETY DEVICE BYPASS KEY

The machine has a key device that acts on the electrical circuit, bypassing the platform safety systems. The device is situated on the cover of the electrical components compartment.

The use of this selector switch is illustrated in the following paragraphs on how to use the machine.



DANGER

Considering the hazard deriving from the use of the platform during the bypass of the safety devices, carefully read the paragraphs regarding the use of the safety device release key selector switch.

The key used to activate the safety device bypass is lead-sealed on the side of the electrical components compartment near the battery.

Force the lead-sealing to remove it. After using the safety device bypass a HINOWA after-sales centre must be contacted in order to verify the causes that determined the need to use the safety device bypass and to lead-seal the key.

The safety device electronic control board records when the safety device bypass key is used and the movements carried out during these operations.

The safety device bypass system is used to move the machine with a higher load than the limit load allowed inside the basket; the overload alarm is nonetheless displayed and the beeper warns the operator of the dangerous conditions. This device must only be used by expert personnel trained on how to use the machine, while the end user, who does not fully know the machine's operating principles, is not allowed to use this device.

5.5 EMERGENCY POSITION CONTROLS

- SELECTION PANEL, EMERGENCY STOP AND STARTING

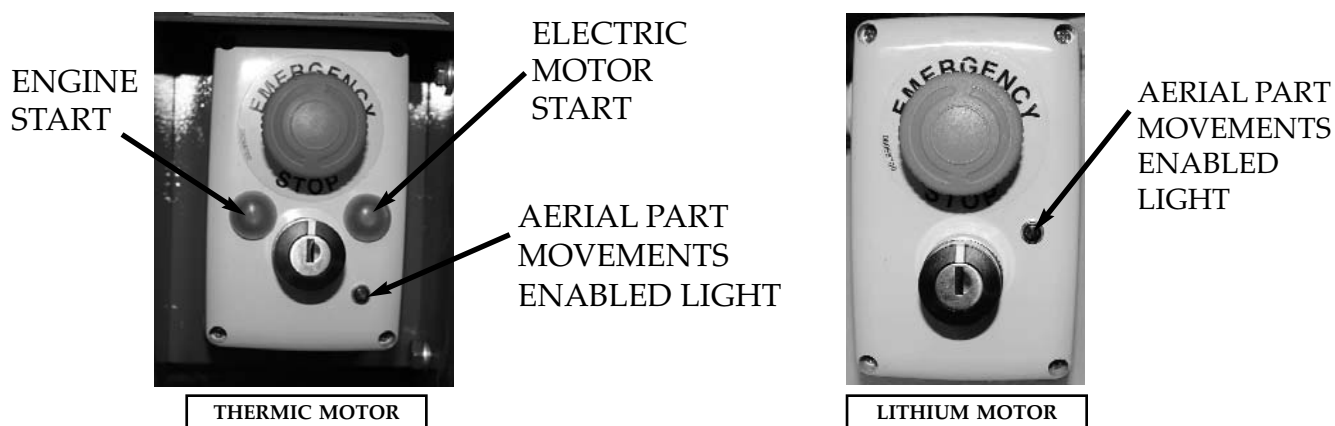

This panel houses the following controls:

- Three-position control for selecting the control position.
 - 1_The central (neutral) position of the selector enables the use of the primary remote control in the basket
 - 2_Turning clockwise and holding it in position enables the emergency control position and energises the main proportional valve on the hydraulic system for moving the arms. On the Lithium version, it also starts the electric motor. The main proportional valve can only be enabled if all the conditions that allow the movement of the aerial part have been satisfied. This is signalled by the icon on the remote control in position 5, and repeated on this panel by the green light coming on (see photo).
 - 3_Turning anticlockwise enables the control position for maintenance using the remote control on the ground; this option can only be used for maintenance operations and for it to be enabled the primary remote control must be in the basket or the remote control cable in the basket must be connected to the special adapter.
- Emergency STOP. If pressed stops the motor and stops the machine. To make the machine operational again, the button must be turned and released.
- START BUTTONS: Enable the selected engine/motor to be started, provided that all the emergency stop buttons have been released and all the conditions necessary for the start of the engine/motor are satisfied.

CONNECTING THE REMOTE CONTROL TO USE IT FROM THE GROUND

The remote control in the basket (or an optional second remote control) can be used for maintenance operations by connecting it to the special socket on the machine.

To do this, proceed as follows:

- If not already in your possession procure the appropriate service kit from ground in an authorized Hinowa centre.
- With the machine off (key on OFF position) connect the service cable for ground remote control to the proper service connector located near the electrical components box under the protective cover, then connect the remote control to the service cable
- Select ground control operating the selector on the controls box.
- If using the remote control provided in the basket as control device from ground, connect the free cable in the basket to the specially provided optional connector supplied in the ground service use kit.
- Turn the key to position ON and start the machine.

The remote control can be used from the ground to perform all possible operations within safety limits if the load in the basket is less than 50 kg. If the load in the basket exceeds 50 kg (always within the machine's load limits), in order to be able to use the remote control from the ground hold button 8 and activate the desired control.



DANGER

IT IS STRICTLY FORBIDDEN TO USE THE REMOTE CONTROL FROM THE GROUND TO MOVE THE MACHINE WHEN AN OPERATOR IS IN THE BASKET.

- AERIAL PART HYDRAULIC DISTRIBUTOR

The hydraulic distributor is fitted with levers and buttons for the selection of the required movement, its direction and speed. The structure is moved by using the levers after holding the key in position.

The meanings of the levers on the distributor are described below:

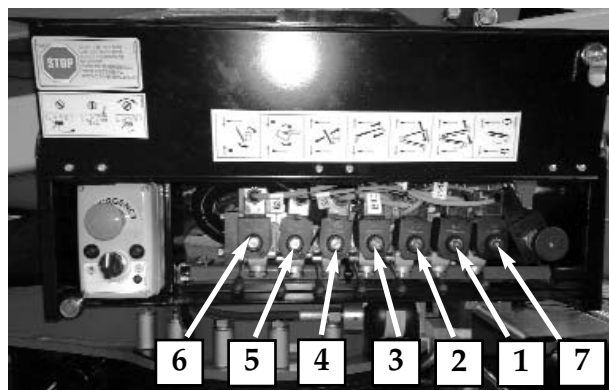

Ref.	Description	Lever/Movement obtained	Pictogram near the control
1	First-second arm control	<i>Moving lever 1 upwards:</i> 1st-2nd arm up <i>Moving lever 1 downwards:</i> 1st-2nd arm down	
2	Third-fourth arm control	<i>Moving lever 2 upwards:</i> 3rd arm up <i>Moving lever 2 downwards:</i> 3rd arm down	
3	Extension arm control	<i>Moving lever 3 upwards:</i> extension arm out <i>Moving lever 3 downwards:</i> extension arm in	
4	Jib control	<i>Moving lever 4 upwards:</i> jib opens <i>Moving lever 4 downwards:</i> jib folds	

SELF-PROPELLED TRACKED PLATFORM LL1775

HINOWA

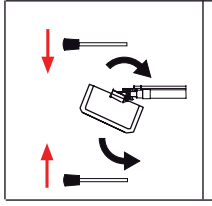
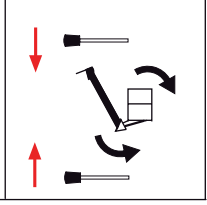
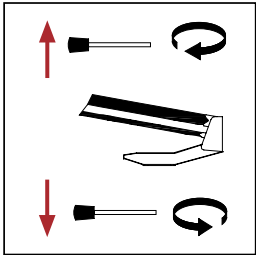
5	Basket rotation control	<p><i>Moving lever 5 downwards:</i> basket rotates clockwise</p> <p><i>Moving lever 5 upwards:</i> basket rotates anticlockwise</p>	
6	Basket levelling control	<p><i>Moving lever 6 downwards:</i> basket opens</p> <p><i>Moving lever 6 upwards:</i> basket closes</p>	
7	Rotation control	<p><i>Moving lever 7 upwards:</i> clockwise rotation</p> <p><i>Moving lever 7 downwards:</i> anticlockwise rotation</p>	

TRACKED UNDERCARRIAGE HYDRAULIC DISTRIBUTOR

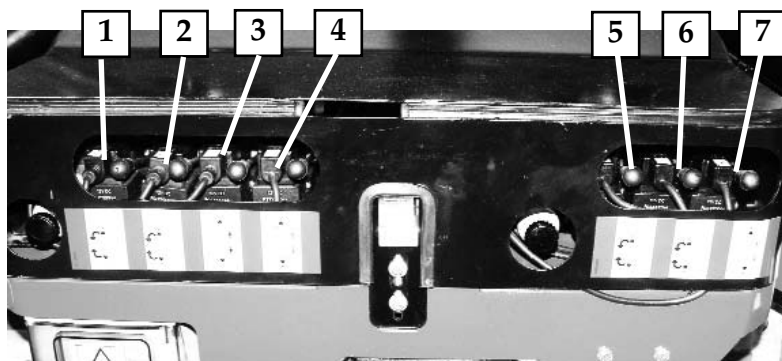

SELF-PROPELLED TRACKED PLATFORM LL1775

HINOWA

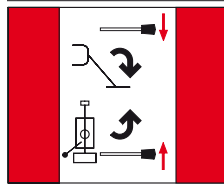
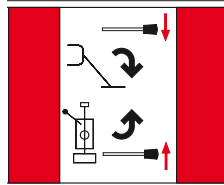
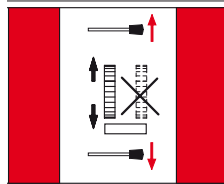
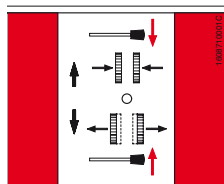
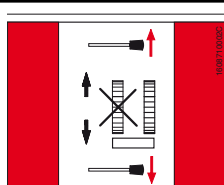
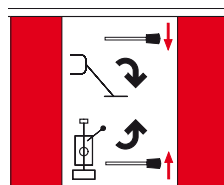
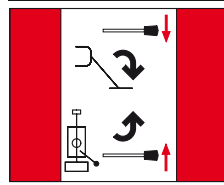
Ref.	Description	Lever/Movement obtained	Pictogram near the control
1	Rear left stabiliser control	<i>Moving lever 1 downwards:</i> rear L stabiliser down <i>Moving lever 1 upwards:</i> rear L stabiliser up	
2	Front left stabiliser control	<i>Moving lever 2 downwards:</i> front L stabiliser down <i>Moving lever 2 upwards:</i> front L stabiliser up	
3	Left track control	<i>Moving lever 3 upwards:</i> moves left track forward <i>Moving lever 3 downwards:</i> moves left track backward	
4	Track extension control	<i>Moving lever 4 downwards:</i> extends track <i>Moving lever 4 upwards:</i> narrows track	
5	Right track control	<i>Moving lever 5 upwards:</i> moves right track forward <i>Moving lever 5 downwards:</i> moves right track backward	
6	Front right stabiliser control	<i>Moving lever 6 downwards:</i> front R stabiliser down <i>Moving lever 6 upwards:</i> front R stabiliser up	
7	Rear right stabiliser control	<i>Moving lever 7 downwards:</i> rear R stabiliser down <i>Moving lever 7 upwards:</i> rear R stabiliser up	

6. USING THE MACHINE

6.1 SAFETY STANDARDS TO ADOPT BEFORE USING THE PLATFORM

6.1.1 RISK OF ELECTROCUTION

If the machine must be used near electric power lines, the user must remain at a suitable distance from the latter. The table below supplies the values relating to the minimum distance from electric power lines depending on the type of voltage.

SAFETY DISTANCE FROM POWER LINES		
LINE RATED VOLTAGE		SAFETY DISTANCE (METRES)
FROM	TO	
0 V	300 V	5
300 V	50 kV	5
50 kV	200 kV	5
200 kV	350 kV	6,1
350 kV	500 kV	7,6
500 kV	750 kV	10,7
750 kV	1000 kV	13,7



Keep a safe distance from mains power lines and electrical systems, considering the possible range of movement of the platform and its oscillation, as well as the possible oscillation of the power lines.



Before starting operation, examine the work area, taking note of overhead power lines, moving machinery, such as overhead cranes and road, rail and building equipment.

6.1.2 DANGER DUE TO ATMOSPHERIC CONDITIONS

DO NOT WORK IN UNFAVOURABLE ATMOSPHERIC CONDITIONS

Do not work in the presence of storms, snow, fog or wind exceeding 12 m/s.
Do not operate the machine when the ambient temperature drops below -10°C or exceeds $+40^{\circ}\text{C}$. Do not recharge the machine when the temperature is below 0°C or above 40°C .



Should it unexpectedly rain, before resuming work always remember to check correct stabilisation of the platform and make sure that the ground is solid. Make sure that water has not penetrated into the electrical contacts.

6.1.3 DANGER DUE TO THE WORK AREA

THE MACHINE CAN ONLY WORK ON COMPACT AND LEVEL GROUND.

Always verify that the slope of the ground in the platform positioning area does not exceed the stabilization max inclination. During the stabilisation phase, use the spirit level positioned in proximity to the main controls to check that the maximum inclination of the coupling with respect to horizontal does not exceed 1° .

Check the route for the presence of persons, holes, overhangs, obstacles, debris and coverings which may hide holes.



IMPORTANT

Before entering any high risk areas (refineries, power stations etc.) check accessibility with plant safety staff.

6.2 PROCEDURES FOR CORRECT USE

Below find the procedures for use of the platform as declared by the Constructor. Any use different to that stated below, unless authorised in writing by the Constructor, is prohibited.

6.2.1 SUMMARY TABLE OF OPERATOR SAFETY STANDARDS

The summary table shown below lists the general safety standards that must be followed scrupulously by the operator before using the platform.

Remember that a sticker with this table can be found near the controls positioned on the basket, where it is well visible from the control position.

- The elevating platform can only be used by specialised, previously-trained personnel.
- All operations of the extensible structures must be performed from the control position in the basket. The travel and stabilisation operations must be carried out after checking that there is complete visibility of the work area. Before starting operation, examine the work area, taking note of overhead power lines, moving machinery, such as overhead cranes and road, rail and building equipment.
- The instructions contained in the USER AND OPERATION MANUAL that is provided together with the machine must be followed scrupulously.
- Do not exceed the maximum allowed capacity indicated in the USER AND OPERATION MANUAL and on the basket.

- The operator must wear a hard hat and a safety harness appropriately attached to the relevant anchorage points on the basket.

Remember that the safety harnesses must be checked periodically.

The use of harnesses is compulsory in accordance with local legislation in each individual country. In countries where the law does not require the use of such safety systems, the employer and/or user is responsible for choosing the system to be used.

- Before starting work, the operator must make sure that all the safety devices are in good working order, and check the efficiency of the main mechanical parts as well as the fuel and hydraulic oil level.

Never operate on soft, rough, slimy ground or on slopes that exceed the allowable gradient, in order to ensure that the platform is completely stable.

Make sure that the stabilisers rest on stable HORIZONTAL surfaces.

- Level the machine's chassis perfectly respecting the maximum allowable gradient indicated in the USER AND OPERATION MANUAL and visible on the spirit level.
- Before performing any movement, check that there are no obstacles in the work area and that no people are in the trajectory.
- It is prohibited to carry out work at a distance of less than 5 metres from power lines and electrical equipment.
- It is prohibited to operate in unfavourable atmospheric conditions.
- It is prohibited to anchor cables, ropes or the like to the platform and to use the platform as a lifting device.
- It is prohibited to secure ladders, stools or the like to the platform basket to increase the

HINOWA

working height.

- Always operate the controls slowly and smoothly, without reversing movements suddenly.
- Remember that the basket must only be loaded and unloaded FROM THE GROUND.
- Do not use the machine at temperatures below -20°C and above 40°C. Do not recharge the batteries at temperatures below 0°C and above 40°C.

SELF-PROPELLED TRACKED PLATFORM LL1775

HINOWA

6.3 WORK AREA

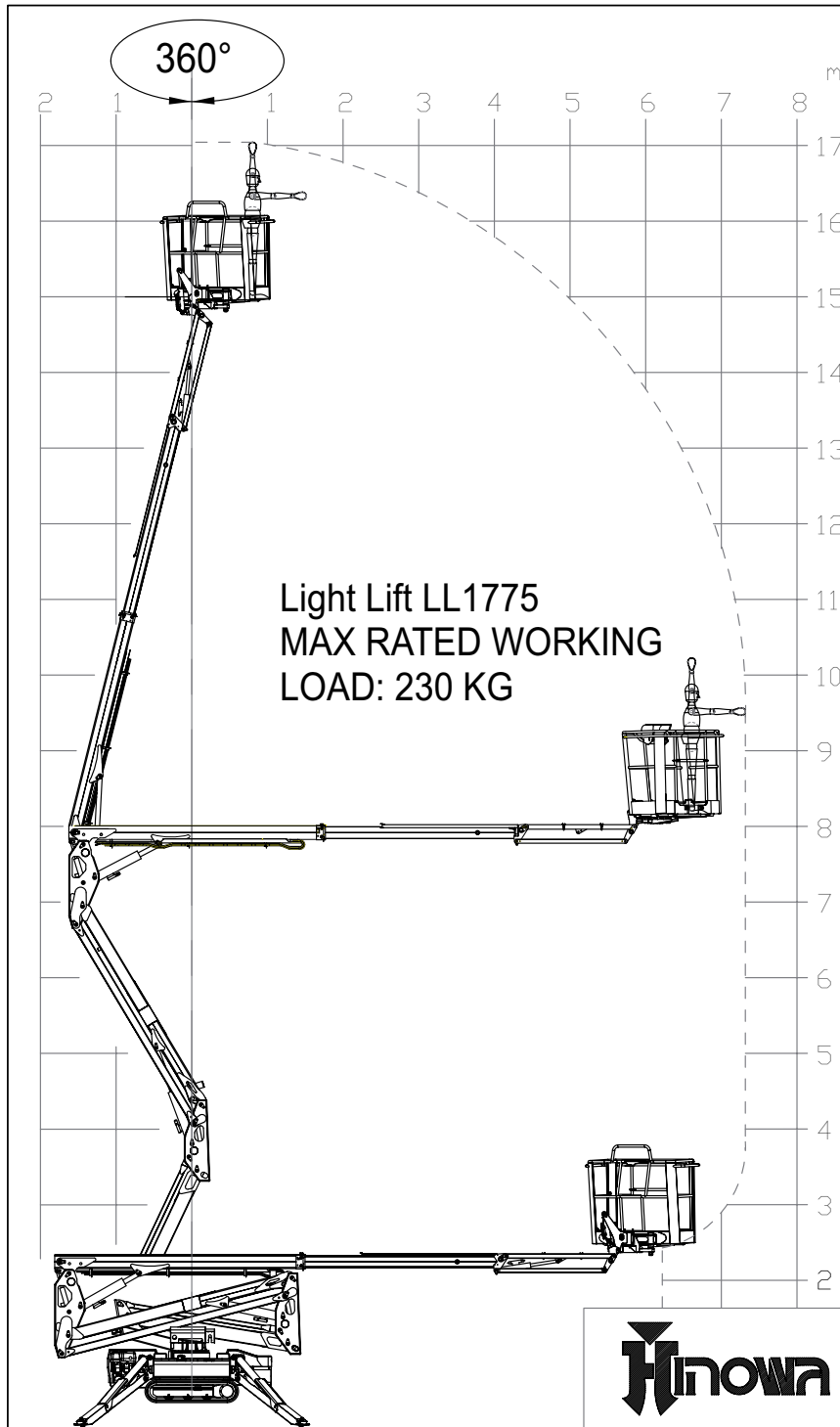

6.4 USE OF THE ELEVATING WORK PLATFORM (MEWP)



IMPORTANT

In the explanations contained in the following paragraphs, it is assumed that the operator has already read and understood the contents of the previous sections of this manual. Therefore, warnings and photos which are already provided in other sections of this document will be repeated only when absolutely necessary.



IMPORTANT

The HINOWA elevating work platforms are suitable for overhead jobs that are performed by an operator from inside the basket. The platform must be used exclusively by skilled personnel who are aware of the position and functions of all controls, instruments, indicators, warning lights and the meaning of the stickers and indications on the machine.

The operator must have understood the platform operating procedures before using it.

Correct use of the platform requires, as well as the presence of the operator (or operators) in the basket, also the presence of an expert operator on the ground who has to supervise work and be ready to intervene in case of dangerous situations and for any emergency operations.

This implies that the personnel on the ground must be suitably trained regarding the functions of the controls and the procedures for use and that they have read the manual.



- Failure to comply with even one safety provision may cause injury/damage to the operators and/or the machine.
- Keep a first aid box and a fire extinguisher near the work area. These must be used in compliance with the regulations in force.
- Do not remain within the platform operating range. The area below must be cordoned off; it is prohibited to throw objects from or towards the basket.
- Wear tight clothing and use all the PPE considered necessary based on the risk analysis of each individual site (shoes, hard hats, gloves and safety belts).
- When the work needs to be performed by two or more persons, before starting always agree on the correct procedure to follow. Always inform your fellow workers before starting the procedure.
- **At low temperatures start the motor and let it run for a few minutes, so that the hydraulic oil circulates and reaches at least 20°C before operating the platform.**

- When climbing into the basket, fasten the safety harnesses immediately to the appropriate fixing points before carrying out any operations. Remember that the safety harnesses must be checked and TESTED PERIODICALLY.
- If the pressure of the stabilisers on the ground exceeds the allowable pressure on the ground, the support surface must be increased by inserting appropriate plates or a substrate of stable material (e.g. wood) between the ground and the stabiliser plate. This material must ensure good friction with the underlying ground and with the stabiliser plate. Any risk of the machine sliding on the ground must be eliminated.

6.4.1 PRELIMINARY CHECKS BEFORE STARTING WORK

Carry out the following checks every day before using the machine:

- Check that there are no leaks from the hydraulic system. If leaks are present, carry out the necessary repairs and top up (see the paragraph on maintenance operations). Clean the area using a solvent or a pressurised solution of water and detergent, taking care to prevent contact with the electrical parts.
- Make sure there is no corrosion and there are no cracks around welded points.
- Check the condition and correct tensioning of the track belts (see the paragraph on maintenance operations).
- Check that there are no broken, damaged or missing components. Check the correct tightness of the pin locking bolts and nuts or the safety locknuts. Before using the machine replace, tighten and adjust them according to the instructions of the platform manufacturer.
- Eliminate debris that may cause fire or breakage, paying particular attention to the machine control area and the area around the diesel/petrol engine.
- Clean the handrails, footboards and control levers removing any oil residues and debris that may affect safety during the operations, thus putting the operator at risk. Check the condition of the indicators and electric controls on the control board positioned on the basket.
- Check the condition of the adhesive labels positioned on the machine to ensure they are easily visible.
- Check that the quantity of fuel in the fuel tank is sufficient, in order to avoid useless down time and emergency descents.
- Check the correct operation of all safety devices.

6.4.2 STARTING THE PETROL/DIESEL ENGINE

Before starting the engine it is necessary to:

- Become familiar with all the procedures described in the USER AND OPERATION MANUAL of the machine and of the engine, and to know the meaning of the safety labels;
 - Examine the safety rule summary table in the manual and follow all the instructions given therein;
 - Make sure that the fuel cap is properly tightened;
 - Make sure that there are no residues of petrol or flammable materials near the exhaust silencer or other areas subject to overheating;
 - Make sure that no one is standing near the machine;
 - Make sure that all the emergency STOP buttons are released; this condition can be checked on the remote control display, where no icon should appear in position 7.
- If the operator attempts to start the machine with the emergency stop button still pressed, an error message will appear on the display when the start button is pressed.

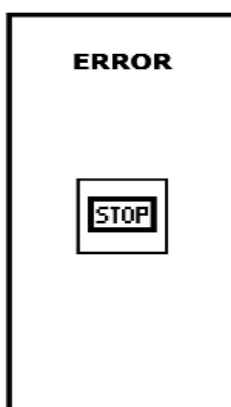

- The engine can be started from the ground using the start key, or directly by means of the remote control. In this case it is necessary to move the engine start key to position ON before getting on the basket. Use the ladder and the handrails to reach the control position. At this point, press the button on the remote control to start the engine.
- The petrol engine starter is automatic.
- If the operator attempts to start one of the two motors while the other is already running, starting will be impossible and the icon showing the motor already on will appear at the centre of the screen.

The machines with petrol engines are equipped with an automatic preheating system, pushing button 10 on remote control the running system is automatically set at 2200 rpm in order to preheat the engine and improve the starting phases of use.

If with this function active a movement that needs a different rotation system is attempted, the machine will automatically exit from the preheating mode and will perform the move-

ment at the necessary speed. See paragraph concerning the functions of the remote control before using this option.



THE ENGINE MUST BE STARTED WITH ALL THE CONTROL BUTTONS AND JOY-STICKS IN NEUTRAL POSITION.

Always make sure there are no foreign objects (e.g. branches) that may accidentally operate a control, as the platform may move suddenly out of the operator's control and cause serious harm to things and/or people.

Make sure that all the manual controls for the proportional valves are at rest.

6.4.3 STARTING THE ELECTRIC MOTOR

- Before starting the motor, be clearly aware of all the procedures described in the USER AND OPERATION MANUAL and get familiar with the meaning of the safety stickers.
- Examine the safety rule summary table in the manual and follow all the instructions given therein.
- Power the machine with an electric cable through the connection positioned at the bottom near the electric motor.
Close the switch located in the electrical panel near the motor (see photo).



Before connecting the machine to the main power supply:

- a) Make sure that the specifications of the power line correspond to the voltage and frequency indicated on the electric motor rating plate.
- b) Check the condition of the power cable; it must be sized for a rated power of 2.2 kW. For connection use a 3x2.5 mm² three-wire cable with F47 ground clamp, double insulation and 16A plug. The maximum cable length must be 10 m.
- c) Place an earth plate in the ground and connect it to the machine's ground clamp or, if this is not possible, make sure the power connection is earthed (e.g. indoors).

- Make sure that all the emergency STOP buttons are released; this condition can be checked on the remote control display, where no icon should appear in position 7. If the operator attempts to start the machine with the emergency stop button still pressed, an error message will appear on the display when the start button is pressed.

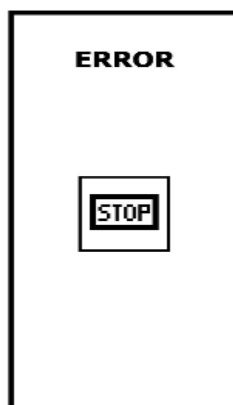

- If the operator attempts to start one of the two motors while the other is already running, starting will be impossible and the icon showing the motor already on will appear at the centre of the screen.
- Use the button on the remote control to start the motor.



THE ENGINE MUST BE STARTED WITH ALL THE CONTROL BUTTONS AND JOYSTICKS IN NEUTRAL POSITION.

Always make sure that there are no foreign objects (for example, branches) that may accidentally operate a control, since the platform may move abruptly, independently of the operator's will, and cause serious injury or damage.

Make sure that all the manual controls for the proportional valves are at rest.

6.4.4 STOPPING THE ENGINE/MOTOR

To stop the engine, press again button 11 on the remote control; it allows the engine to be switched off or on depending on its status.

To stop the electric motor, press button 12; it allows the electric motor to be switched off or on depending on its status.

6.4.5 STOPPING THE MOTOR LITHIUM VERSION

To switch off the electric motor, release the button or the lever on the remote control or release the emergency control key.

The motor will stop automatically in 3-4 seconds.



The electric motor can only be considered stopped if one of the emergency stop buttons on the machine is pressed.



Whenever a movement of the machine has been completed and work needs to continue with the machine off, one of the emergency stop buttons must be pressed and left activated.



The machine must not be left off with the electronic board and the remote control powered.

6.4.6 TRAVEL

The HINOWA machine is a self-propelled machine able to easily move on any type of ground, over steep slopes (up to 15°) and, considering the small dimensions, to enter narrow openings. One condition for travel is that the four stabilisers are lifted from the ground and the machine is in the transport or stabilisation configuration.

Travel can only be controlled from the position on the ground, always keeping a minimum distance of 1 metre from the machine during ALL control operations.



WARNING

When controlling the machine, before travelling make sure that the control position guarantees a perfect view of the entire machine and EVERY obstacle that may be in the machine's trajectory.

If a very precise control of travel movements is required, the motor speed can be reduced by means of the speed selector button on the remote control.

Pay attention to the overall dimensions of the machine, especially if the stabilisers are not turned to the transport position.



It is prohibited to get on or off the basket if this is not completely lowered.



The machine is not type-approved for road circulation. The work and autonomous shifting areas must be appropriately delimited and with signs according to the laws in force regarding this subject. The machine must be loaded onto type-approved machines for any movement on public roads.



WARNING

- During control operations, always keep a **minimum distance of 1 metre** from the machine.
- It is recommended to travel on flat surfaces with the stabilisers completely lifted and set in the transport position, so as to reduce the overall dimensions of the machine. Travel is only allowed with carriage extended to the maximum width whenever possible in the place of travel. This makes steering easier and increases machine stability.
- **The 2nd travel speed can only be used for travelling in a straight line on solid and level ground.**

TRAVEL PROCEDURE

Before travelling, proceed as follows:

- Check that all instructions previously given in this chapter have been complied with;
- Make sure that the ground is compact and can support the weight of the machine;
- Check that there are no obstacles in the travel area, considering the overall dimensions of the machine;
- The machine is completely closed and aligned, in the transport or stabilisation position or with the jib arm partially or totally lifted in the transport or stabilisation position. **This configuration is ONLY ALLOWED WHEN STRICTLY NECESSARY.**
- Select the travel speed according to the need and as described above, operating the relevant button and checking the selection on display;
- Operate joysticks 1 and 8 to move the tracks;

If the operator attempts to travel with one or more stabilisers on the ground, an error message will appear on the display warning the user to raise the stabilisers in order to allow the machine to travel.

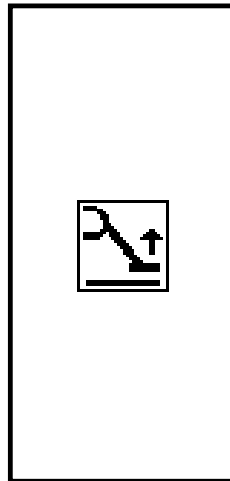

TRAVELLING ON SLOPES

The maximum slope for travel is shown in the machine specifications at the beginning of this manual.

When travelling on inclined surfaces, lower the stabilisers on the downward side for further safety in the event of sudden changes in slope.

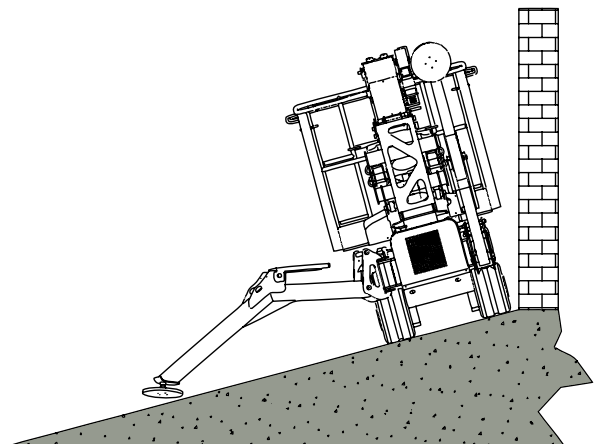



DANGER

The machine is equipped with an automatic system of inclination sensing during translation, the possible translation speeds are adjusted according to the weight in basket, undercarriage closed or opened, position of JIB and inclination of the ground.

In case of approach to dangerous inclinations for machine's stability, both lateral and longitudinal, a beeper is activated and afterwards the translation is forbidden. The only allowed operation to exit this condition is activate the consent to movement pressing button 8 on remote control and bring the machine in safety condition reducing the inclination, it is absolutely forbidden to increase the inclination of the machine as it could cause overturning with consequent danger for operator or people nearby the machine.



DANGER

The safety systems introduced to limit the risks of the manoeuvre are a valid help to the operator but unfortunately cannot eliminate dangers caused by improper or regardless use of the machine.

It is operator's responsibility to run the machine safely, checking the ground conditions, evaluating the obstacles and dangers in the working area and following the rules of this manual and indications on decals and display of the machine.



WARNING

Do not use the second travel speed to drive on sloping or uneven ground and when not driving in a straight line.

6.4.7 JIB ARM MOVEMENT FOR TRAVEL

To take on slopes from 10° to 15° in a longitudinal direction during travel, the jib arm can be raised.



WARNING

PERFORM THIS OPERATION ONLY WHEN REALLY NECESSARY. IN ALL OTHER SITUATIONS, TRAVEL WITH THE MACHINE CLOSED AND ALIGNED.

Enabling of the jib is indicated by the icon in position 5 on the remote control.

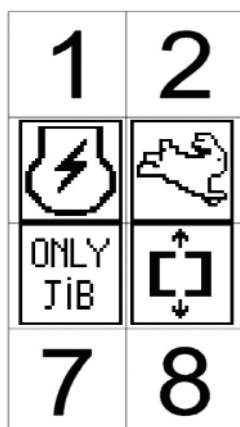

The jib arm can be raised during travel only from the control position on the ground.

Before raising the jib arm for travel, check the following conditions:

- All the stabilisers must be lifted from the ground;
- No operators must be in the basket;
The control position on the ground must be used (the remote control must not be in place in the basket);
- The aerial part safety device bypass key must not have been activated after the machine has been closed and aligned.

If one or more of these conditions is not satisfied, the jib arm cannot be used and one of the following error screens will be shown.

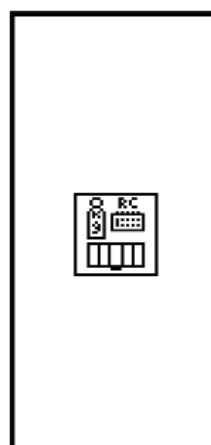
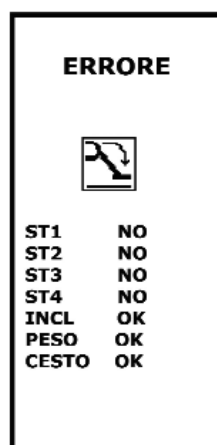

After the conditions described above have been checked, make sure there are no obstacles in the working area of the jib arm, and proceed as follows:

- Use joystick 6 to move the jib arm. If another joystick is used, an error message will be shown on the display:

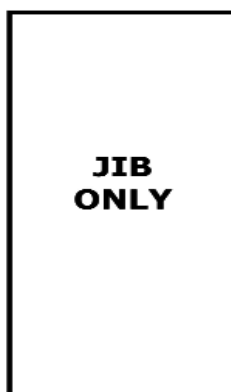

- **AFTER PASSING THE INCLINE THAT REQUIRED THE JIB ARM TO BE OPENED, RETURN THE MACHINE TO THE CLOSED CONFIGURATION TO CONTINUE TRAVELLING.**
- With the jib arm raised always travel at minimum speed and keep the jib arm as close to the ground as possible.
- DO NOT travel downhill if the jib arm is not completely folded.

6.4.8 PARKING THE MACHINE ON A SLOPE OR ON UNEVEN GROUND

When parking the machine on a slope or uneven ground with the stabilisers closed, make sure that the carriage is in the open position and block the tracks using chocks to prevent the machine from moving.

- **Do not use the second travel speed to drive on sloping or uneven ground and when not driving in a straight line.**

6.4.9 STABILISING AND LEVELLING THE MACHINE

Once having decided where to park the machine, this can be stabilised and levelled. First of all check that the surface can support the pressure exerted on the ground by the machine (see the paragraph on technical specifications) and can contain the overall dimensions of the machine with stabilisers lowered.



DANGER

Stabilising the machine on a slope exceeding the allowed limits may cause instability and consequently harm to or even death of operators or other persons in and around the working area. Work must only be performed with the machine stabilised at an inclination under the limits specified by the manufacturer.

- Always keep a distance from embankments or ditches that is equivalent to the depth of such and observe the required safety distance from power lines.
- Avoid any contact with objects or persons when lowering the stabilisers.

STABILISATION PROCEDURE

Before moving the stabilisers make sure that:

- all instructions provided in this chapter have been complied with;
- the ground where the machine is stabilised is compact and can support the weight of the machine and the maximum possible reaction force on one stabiliser;
NOTE: when working the load on one individual stabiliser can increase greatly due to the shifting of weight, especially if extension and/or rotation operations are performed. THIS MUST ALSO BE CONSIDERED WHEN EXAMINING THE GROUND.
- there are no obstacles on the stabilisation area and in the trajectory of each individual stabiliser;
- the machine is completely closed and aligned, in the stabilisation position.

The complete closure and alignment is displayed by the arrows on the machine (SEE PHOTO) and the display of the icon in position 6 on the remote control.

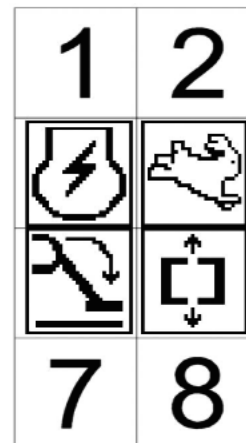
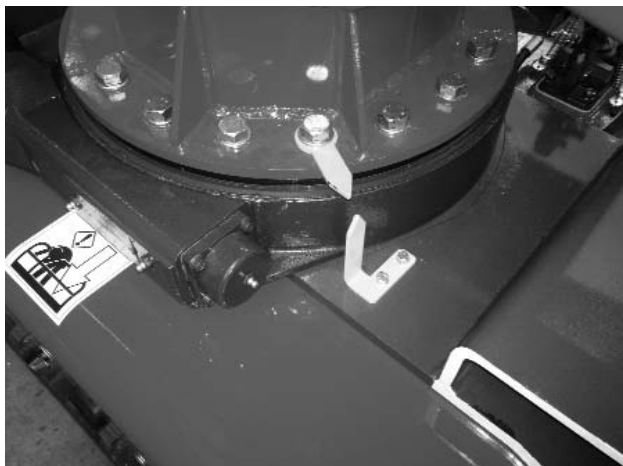

- Stabilisation can be carried out from the control position in the basket or on the ground. If performing the operation from the ground, make sure there is complete visibility of the trajectory of each individual stabiliser before moving it and check that at the end of the stabilisation procedure the distance between the ground and the lower limit of the basket access ladder is less than 40 cm. If this is not the case, move the ladder to the ground and carry out the stabilisation procedure from the basket.
- Select the motor speed as required and check the selection on the display. Always perform stabilisation at slow speed.
- Press and hold the automatic stabilisation button 7 (see the corresponding paragraph). If the movements are selected with the machine not completely closed and aligned, an error message will be shown on the display.

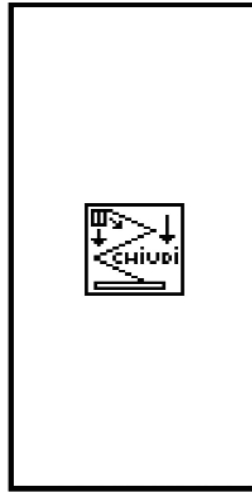

- Stabilisation will be completed when the machine is in horizontal position with tolerance of 1° and lifted at least 5 cm from the ground. Correct stabilisation will be confirmed by the icon in position 5 on the display.
Always check the spirit level and make sure the slope is actually less than 1°.

MANUAL STABILISER CONTROL

The manual control of the stabilisers must not be used to stabilise the machine but only to correct its inclination in the event of stabilisation in difficult conditions. It can also be used to lower or lift the stabilisers individually in order to increase the stability of the machine, if it is necessary to transit areas with obstacles or steep slopes.

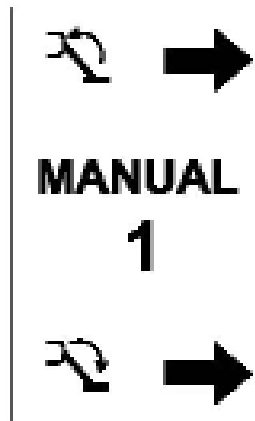

Pressing the button once shows the screen for the manual operation of stabiliser 1, pressing it a second time shows the screen for stabiliser 2 and so on until stabiliser 4. Pressing it once again shows the initial display.

In the manual menu, pressing buttons 1 and 7 raises or lowers the selected stabiliser.

To verify the inclination of the chassis a spirit level is provided on the machine; when the air

bubble it contains is completely inside the green area (see photo below) the machine is in conditions that allow operation.

Please note that stabilize the machine on slopes greater than allowable limits (see technical data of the machine) does not permit correct stabilization and is a serious danger for users.

On each stabiliser (see photo below), near the cylinder coupling, there is an orange light. This light flashes to indicate that the stabiliser is resting on the ground.

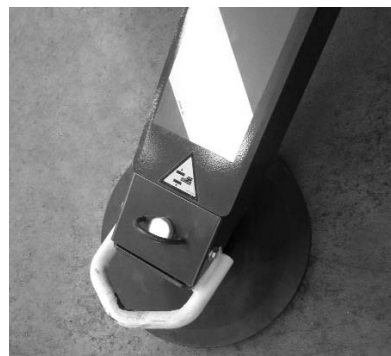

Note: IT IS IMPORTANT TO REMIND THAT WHEN THE STABILISERS ARE LOWERED THE CARRIAGE MUST ALWAYS BE RAISED FROM THE GROUND.



IMPORTANT

AFTER USING THE MANUAL STABILISER CONTROL, REMEMBER TO PRESSURISE THE BOTTOM OF THE STABILISER CYLINDERS. TO DO THIS, RUN AN AUTO-STABILISATION CYCLE OR LOWER EACH STABILISER FOR ONE SECOND.



An electronic spirit level on the electronic control board checks that the machine is effectively level within the allowable tolerance and enables the movements of the aerial part.



Incorrect machine stabilisation does not ensure suitable stability to perform operations. The Constructor prohibits the use of the machine if it is not stabilised as described in this manual; the machine overturning may cause serious injury to or even death of its occupants and personnel on the ground.

If one of the orange lights positioned on each stabiliser should flash even when the stabiliser is lifted from the ground, stop the machine immediately and call the after-sales service as this signals the breakage of the corresponding stabiliser microswitch.



If working with the machine stabilised on slippery surfaces (marble, porphyry, polished cement, smooth damp surfaces etc.) check that the movements of the basket do not cause the tracks to move. If so, stop the operations and restore the safe operating conditions prescribed by the manufacturer.



WARNING

**Make sure that the stabilisers rest on horizontal ground.
DO NOT REST THE STABILISERS ON VERTICAL OR INCLINED SURFACES.**

6.4.10 AUTOMATIC LOWERING AND RAISING OF THE STABILISERS

HINOWA elevating platform is fitted with an innovative automatic levelling procedure that acts on the stabilisers and uses the electronic spirit level provided on the main control board. For the self-levelling procedure, all the precautions described to this point apply.

Before starting the self-stabilization make sure that the machine is on a slope less than the total permitted limit for stabilization (see technical data of the machine) and verify that the trajectory of the stabilizers is free of obstacles and impediments.



WARNING

The automatic procedure for levelling the machine extends and retracts the stabilisers, and consequently moves the machine. Always check that there are no people, animals or things in the stabilisation area.

- AUTOMATIC LOWERING OF THE STABILISERS

Press and hold button 7 on the remote control.



The success of the self-levelling procedure is confirmed by an icon displayed on the screen for several seconds.

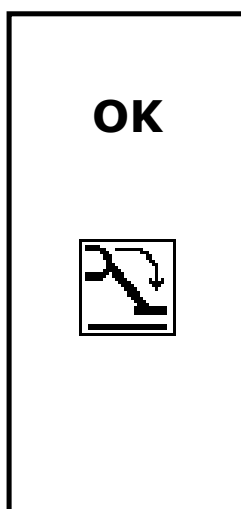

If the selfstabilization procedure has not been completed and the OK message has not appeared on the display it will not be possible to move the aerial part of the machine and at every attempt to do it an error message will appear: AUTOSTAB NO. Repeat the Selfstabilization operation to enable movements.

After the end of the procedure, always control that the spirit level is in the green zone. If this does not occur contact HINOWA after sales service.

If during lowering one of the stabilisers does not touch the ground, the machine will continue to operate the cylinder at the end of its stroke until the motor switches off or the self-levelling procedure ends. This situation is normal and indicates that the slope the machine is situated on exceeds the allowable limit for stabilisation. If at the end of the stabilisation phase the machine has to be lifted even further from the ground, a new self-levelling procedure can be run.

NOTE: using the self-levelling procedure does not affect the operation of the stabilisers in manual mode.

- AUTOMATIC RAISING OF THE STABILISERS

Press and hold button 1 on the remote control.

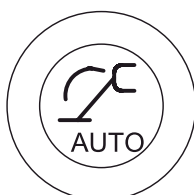

The four stabilisers will start to lower the machine and then will retract completely.

The end of the automatic stabiliser raising cycle is shown on a screen for a few seconds. If this screen is not shown, the automatic stabiliser raising procedure can still be considered completed once all the four stabilisers have been completely retracted and consequently the relevant cylinders are at the end of their stroke.

If problems occur during either of these procedures, immediately release the selected button to stop all the movements. Stabilising the machine on a slope exceeding the allowed limits may cause instability and consequently harm to or even death of operators or other persons in and around the working area. Work must only be performed with the machine stabilised at an inclination under the limits specified by the manufacturer.

The elevating platform is considered stabilised when the slope is less than 1° and the tracks are raised at least 5 cm from the ground. NEVER WORK AT A HEIGHT WITH THE TRACKS NOT COMPLETELY RAISED FROM THE GROUND.

6.4.11 TRACK GAUGE EXTENSION

To adjust the track gauge, proceed as follows:

- Use buttons 3-9 to extend/narrow the track gauge.

NOTE: the track gauge extension operations should be performed with the machine stabilised and lifted from the ground. If this is not possible, perform the extension operations with the tracks moving.

Do not extend/narrow the track gauge when the tracks are stationary and resting on the ground.

6.4.12 MOVING THE BASKET

Once the machine has been stabilised correctly (check the icon in pos. 5), the basket can be moved.



- It is prohibited to load material of any type into the basket if the machine is not stabilised and completely closed. To load and unload the basket the icon in position 6 on the remote control must be displayed. Loading material into the basket when it is lifted (e.g. from roofs, balconies etc.) causes the machine to overturn, exposing the occupants and personnel on the ground to potential risk of death.
- It is absolutely forbidden to use the machine to lift loads both in the basket and connected in other way to the structure; the machine can lift two persons (80 kg each) plus 70 kg of tools.
- During machine lowering, near where the upper arms rest on the lower ones, a potential shearing risk is created, appropriately signalled by stickers; it is the user's responsibility to move any persons away from this area.

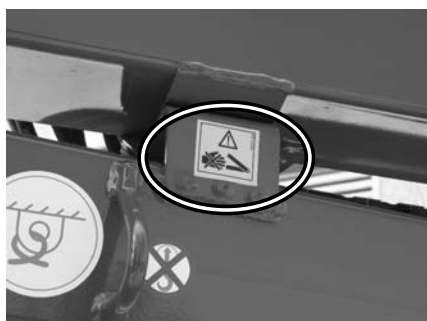

- Pay maximum attention to obstacles that may collide with the various parts of the machine during movement. Before carrying out ANY movement, make sure that nothing can interfere with ANY part of the machine (branches, protruding parts of buildings, etc.).



It is prohibited to introduce objects into the basket that provide high resistance to wind pressure (e.g. large signs) even if they are within the machine's capacity limits.

PROCEDURE FOR ROUTINE MOVEMENT OF THE AERIAL PART

- Before moving the aerial part, make sure that:
 - all instructions provided in this chapter have been complied with;
 - there are no obstacles in the work area;
 - all the conditions necessary for working at a height are met:
the machine is stabilised and levelled: icon 5 shown on the display,
the weight in the basket is below the maximum allowed,
the remote control is positioned in the basket.
 - the basket access ladder has been folded into the raised position so as not to risk contact during movement of the aerial part.
- The aerial part can ONLY be moved from the control position in the basket.
- Select the motor speed as required and check the selection on the display.
- Use joysticks 2, 3, 4, 5, 6, 7 to move the aerial part as described in the paragraph regarding the description of the controls.
- If the movements are selected when one of the conditions listed above is not satisfied, an error message will be shown on the display indicating what conditions are OK and what are not satisfied (FAIL). If the missing condition is stabilisation, the message will also indicate what stabiliser is not resting on the ground.

ST1: if OK stabiliser 1 is resting on the ground

ST2: if OK stabiliser 2 is resting on the ground

ST3: if OK stabiliser 3 is resting on the ground

ST4: if OK stabiliser 4 is resting on the ground

INLC: if OK the machine is under the maximum inclination limit

LOAD: if OK, the load is less than the maximum working load allowed

BASKET: if OK the remote control is in place in the basket

PEDAL: if OK the footswitch is pushed

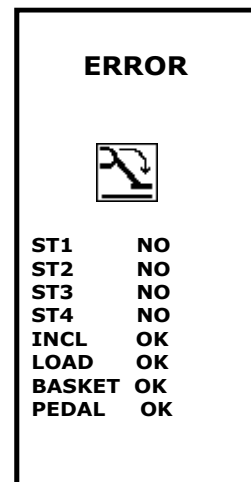

OVERLOAD ALARM

If during the basket loading phases the max allowable load is exceeded based on the position of the jib arm, all movements of the aerial part will be disabled and an error message will be shown on the display, first on the entire screen and then in position 5.

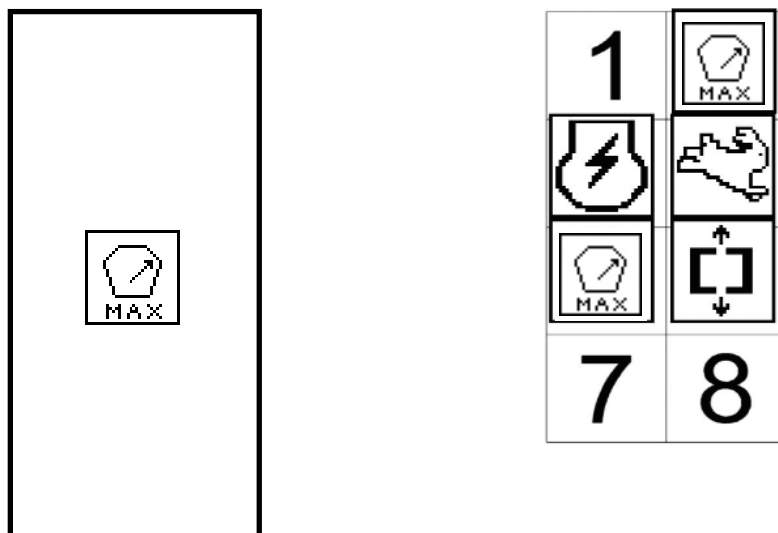

The alarm will only be reset when the overload is removed. Normal machine operation can be resumed only then.

BASKET LIFTING ALARM

If when using the machine at a height, for whatever reason, the basket is lifted from its position on the load sensor, an alarm prevents all movements of the machine and the display on the remote control shows an error message.

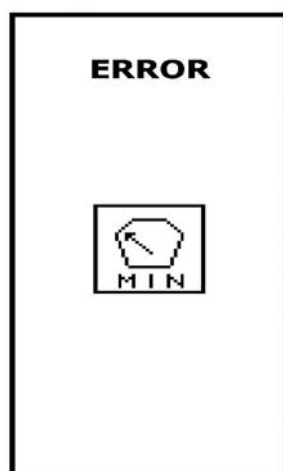

The alarm is reset only when the basket is fitted back on the load sensor.

ROTATION WITH 1ST-2ND ARM FOLDED AND 1ST-2ND ARM DESCENT ON THE THERMIC/LITHIUM ENGINE

If the turret is rotated with the first or second arm folded or nearly folded, there is the risk of the first arm hitting against the engine. For this reason, free rotation areas and limited rotation areas are defined.

LIMITED ROTATION AREA: is an area near the engine where this may be hit by the first arm.

FREE ROTATION AREA: is the rest of the rotation area that does not coincide with the limited rotation area.

These two areas are identified through the combined control of two sensors: a microswitch that verifies the height of the first and second arm, and a proximity switch mounted inside the turntable that senses the position of the turret while it turns.

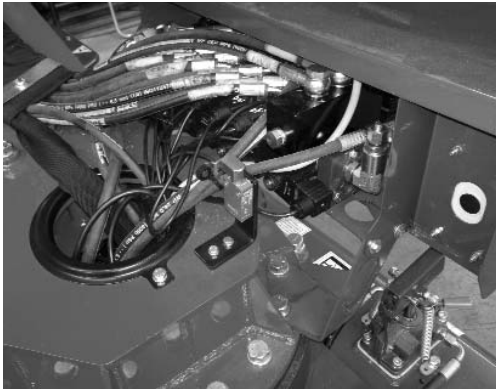

6.4.13 MANUAL LEVELLING OF THE BASKET

The HINOWA elevating work platform is provided with an automatic basket levelling device that was designed so that the basket floor is always parallel to the ground independently of the movements of the arms.

However, due to causes such as leaks and malfunctions, it may be necessary to operate manually to bring the basket to the optimal position. Proceed as follows to make such adjustments:

- try to move the basket to the travel position by closing the extensible structure completely (this, only if the problem occurred while the basket was in a raised position);



- only carry out this operation if the basket angle exceeds 10°. If this is not the case, carry out manual levelling at the minimum possible height, within the limit of 10°. The minimum height is reached by completely closing the 1st and 2nd arm, extension arm, jib arm and, as much as possible, the 3rd arm;
- Insert the key into the corresponding slot in the remote control (see photo);
- Turn the key in the direction corresponding to the required movement.



Basket levelling is subjected to some conditions:

- it is an exceptional manoeuvre to be performed only in case of slight malfunctions of the self-levelling procedure, therefore if the problem occurs frequently, have the basket checked by an authorised workshop;
- the manual levelling control is allowed only from the basket, with the extensible structure completely closed and aligned, otherwise the operator may be seriously injured following contact with moving parts of the machine;
- it is absolutely forbidden to use the levelling manoeuvre for purposes other than those described herein (e.g. to lift objects, to increase the reach of the platform etc.), in order to avoid serious and even fatal accidents.

6.5 EMERGENCY OPERATIONS FOR THE AERIAL PART

The machine was designed considering possible emergency situations such as mechanical and electrical breakdowns, sudden operator illness etc. In all of these cases the machine can be operated both from the basket and from the ground so as to bring it back to the transport configuration or however in such a way as to rescue the occupant/occupants from the basket. These operations are described below.



Personnel must be present on the ground at all times during platform operation.



The operations described below must be performed in SEQUENCE, starting from the first and then continuing with the following ones until the last only if the emergency operation being performed has not been successful.

6.5.1 EMERGENCY DESCENT CONTROLLED FROM THE BASKET

The basket emergency descent procedure can be controlled from the basket itself only if the electrical system of the machine is working; proceed as follows:

- hold button 4 on the remote control (paragraph 2.1.1 *Control position*);
- check the control through icon 8 on the display (paragraph 4.2.1 *Display main screen*);
- use the joystick corresponding to the arm being folded until reaching the required height (paragraph 4.3 *Joystick*);
- release button 4.

As descent is due to gravity, the platform and basket cannot be rotated and the telescopic arm cannot be extended or retracted, therefore the basket is lowered vertically at a distance from the centre of rotation that depends on the configuration of the machine at the time when the emergency situation occurred.

If a joystick corresponding to a movement without emergency descent is activated, an error icon will be shown on the display:

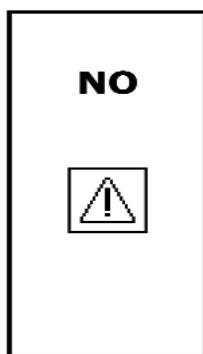

The message disappears when the joystick is released.

6.5.2 OPERATING THE MACHINE FROM THE EMERGENCY CONTROL POSITION ON THE GROUND IF THE OPERATOR IS TAKEN ILL

This function is only used if the operator in the basket becomes suddenly ill and unable to perform ordinary movements and the emergency descent of the basket.



The sole purpose of the emergency descent from the ground is to operate in the event of system breakdown and to bring the basket to the ground, all other uses are prohibited.

For information on the controls in the emergency position, see the paragraph *Emergency position controls*.

- Withdraw the opening key of the distributor's controls protection from the engine keys group in the electrical components box.
- Insert the key to open the distributor's controls protection and access the controls.
- Operate on the enabling selector in the control panel of the emergency position, rotating it clockwise and keeping it in position (in the Lithium version this starts the engine).



THERMIC MOTOR



LITHIUM MOTOR



- Start the motor using the corresponding button in case of thermic version.
- Rotate the key selector clockwise and hold it in position (in Lithium version this starts the motor).
- Make sure that the green indicator light on the emergency position control panel comes on, i.e. that the conditions necessary to be able to move the aerial part are satisfied.
- **Move the aerial part of the machine using the manual levers positioned on the distributor on the ground as described on the sticker placed near them and as specified in this manual.**
- Close the protection and put the keys back in their original position.

6.5.3 EMERGENCY DESCENT IN THE CASE WHERE THE STABILISERS ARE ACCIDENTALLY RETRACTED

While it is recommended to follow the instructions provided in the paragraph on stabilising the machine, for various reasons one of the stabilisers may lose contact with the ground, thus changing the angle of the machine or causing a foot plate to lift from the ground. If this occurs when the machine is at a height, movements are stopped and disabled immediately. To restore operation of the platform (close the aerial part and then stabilise the machine again) the electrical emergency descent function can be used, which involves only the return of the aerial part.

If this is not possible due to the presence of objects that interfere with the operation, personnel on the ground can allow the operator in the basket to close the machine.

The operators on the ground can bypass the machine's safety devices and allow the operator in the basket to close the machine or allow the manual operations as described in the previous paragraphs, in order to bring the operator back to the ground.



WARNING! DANGEROUS OPERATION

Read the instructions provided below before performing the operation as it is potentially dangerous for the operator in the basket.

Proceed as follows:

- Open the electrical components compartment.
- Position the emergency key on the electrical components compartment, removing it from the side where this is lead-sealed (see photo);



- Turn the emergency key anticlockwise and hold it in position (see sticker).

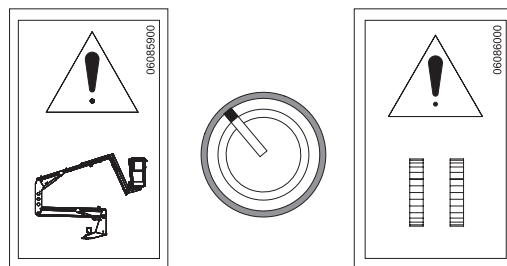

The display on the remote control shows the safety device BYPASS icon.

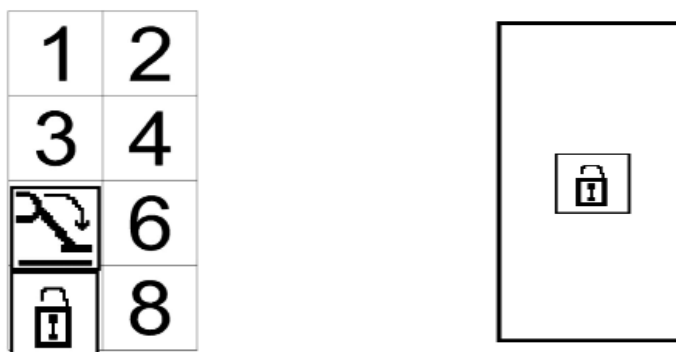

Control the machine with the remote control ONLY carrying out operations that allow the machine to be closed: first/second arm folding, extension arm in, jib arm folding. The third arm can be rotated and lowered only with the extension arm completely retracted.



DO NOT CARRY OUT ANY OPERATIONS OTHER THAN THOSE LISTED OR OPERATIONS THAT MAY AFFECT THE STABILITY OF THE MACHINE. THE ARM MOVEMENT SEQUENCE MUST BE CARRIED OUT IN SUCH A WAY AS TO AVOID ANY OPERATION THAT MAY AFFECT THE STABILITY OF THE MACHINE.

- Once the machine is closed, release the key, remove it and put it back in its original position.
- The electronic control board records every time the safety device bypass key is used.

6.5.4 EMERGENCY DESCENT CONTROLLED FROM THE GROUND USING THE HAND PUMP IN THE EVENT OF FAULTS ON ALL ENERGY SUPPLY SYSTEMS

This emergency descent function is only used if the electrical system and motors break down, meaning one of the previous emergency operations cannot be performed.



The sole purpose of the emergency descent from the ground is to operate in the event of system breakdown and to bring the basket to the ground, all other uses are prohibited.

The emergency descent from the ground can only be carried out using the hydraulic hand pump; to move the basket, pump oil manually and simultaneously use the ground controls for the arm movements.



During this procedure it is prohibited to perform any operations other than those described above, for example to extend the telescopic arm or the jib arm, to move the stabilisers and generally to perform operations that may cause the machine to lose stability.

To perform the emergency descent in the conditions described above, proceed as follows:

- Position on OFF the engine key and disconnect completely the machine from the battery removing the battery cut-off.
- Move the switch located on the hand pump to the position corresponding to movement of the aerial part.
- Withdraw the opening key of the distributor's controls protection from the engine keys group in the electrical components box.
- Insert the key and open the distributor's controls protection to access the controls.
- Press and hold the valve enabling knob.

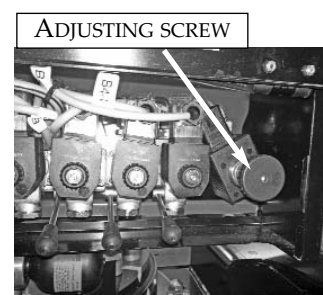

- Use the levers and/or buttons corresponding to the ON-OFF coils accessible from the bottom of the distributor protection so as to enable the required movement, following the instructions on the sticker positioned near the controls, and at the same time operate the hand pump to obtain the movement.

The sequence of movements is the following:

- retract extension arm
- fold jib arm
- fold first-second arm
- fold third arm.

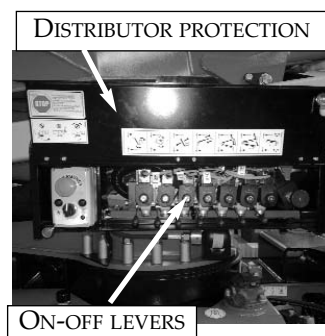

- At the end of the emergency operation close the protection, remove the key and put it back in its original position.



DANGER

IF THIS DEVICE HAS BEEN USED TO MOVE THE MACHINE, BEFORE USING THE MACHINE AGAIN TO WORK AT A HEIGHT IT IS COMPULSORY TO SET IT IN THE TRANSPORT CONFIGURATION (MACHINE CLOSED AND ALIGNED), TO RAISE THE STABILISERS AND LOWER THEM AGAIN. ONLY THEN IT WILL BE POSSIBLE TO WORK WITH THE MACHINE AT A HEIGHT CONTROLLING IT FROM THE BASKET.



DANGER

IT IS PROHIBITED TO RELEASE THE AERIAL PART PROPORTIONAL VALVE FROM THE REST POSITION WITH THE MOTOR RUNNING.

THIS OPERATION WOULD BE VERY RISKY FOR THE SAFETY OF THE OPERATOR ON THE PLATFORM.

6.5.5 EMERGENCY OPERATIONS ON THE CARRIAGE: MOVING THE PLATFORM STABILISERS USING THE HAND PUMP TO ALLOW THE MACHINE TO BE TRANSPORTED



THE HYDRAULIC HAND PUMP CAN BE USED TO MOVE THE STABILISERS AND SET THE MACHINE IN THE TRANSPORT CONFIGURATION ONLY AFTER CLOSING COMPLETELY THE AERIAL PART OF THE PLATFORM.

To raise the stabilisers from the ground in order to be able to transport the machine, proceed as follows:

- check that the machine is completely closed and aligned;
- remove the protection guard from the carriage distributor compartment;
- activate the two proportional valves mounted on the two distributors through the proper devices (A);
- to move the left stabilisers, move the switch on the hydraulic hand pump to the corresponding position; manually switch the aerial-tracked part switch via the fuse in the centre of the magnet, using the corresponding hand wheel;
- use the ON-OFF coil levers and buttons (B) to enable the required movement and simultaneously operate the hand pump to deliver oil to allow the movement (photo C);
- to move the right stabilisers, move the switch on the hydraulic hand pump to the corresponding position;
- use the ON-OFF coil levers and buttons (B) to enable the required movement and simultaneously operate the hand pump to deliver oil to allow the movement (photo C);
- **At the end of these emergency operations fully unscrew the knob of the aerial part/undercarriage part deviator, put the protection back on the distributors**

AERIAL PART-CARRIAGE SWITCH



LEFT SIDE CARRIAGE DISTRIBUTOR

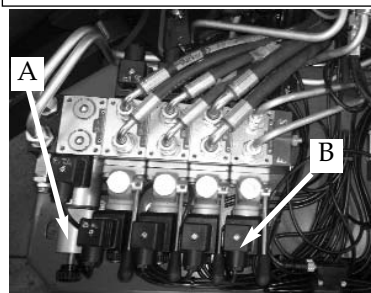

RIGHT SIDE CARRIAGE DISTRIBUTOR

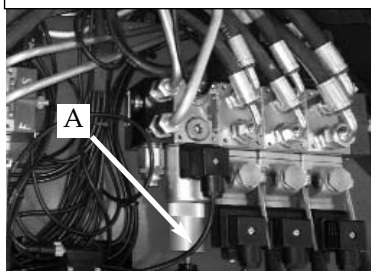

Photo C

6.5.6 EMERGENCY OPERATION OF THE UNDERCARRIAGE IN THE EVENT OF MOVEMENTS OF THE AERIAL PART



THE MANOEUVRE DESCRIBED BELOW MUST BE CARRIED OUT ONLY AND EXCLUSIVELY WITH THE MACHINE CLOSED.

During transport, the aerial part of the machine may turn, consequently becoming misaligned. If this occurs, one of the two EMERGENCY PROCEDURES described below can be applied:

A) Machine realignment:

- Open the electrical components compartment.
- Place the emergency key on the electrical components compartment, removing it from the machine's key holder, where it is sealed with lead (see photo).
- Turn the emergency key anticlockwise and hold it in position (see sticker).



The display on the remote control shows the safety device BYPASS icon.

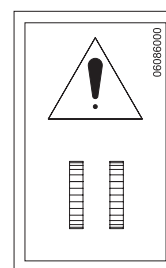
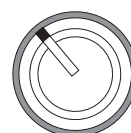
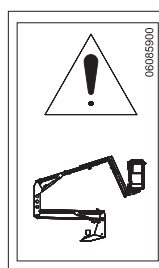
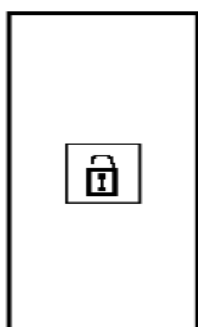

- Realign the machine, controlling it from the basket by means of the remote control.



PERFORM EXCLUSIVELY THE ROTATION MANOEUVRE

- Once the machine has been aligned, release the key, remove it, put it back in its original position and close the electrical components compartment.

B) Moving the undercarriage with the machine not aligned:

OPERATION ALLOWED ONLY TO REACH THE CONDITIONS NECESSARY TO PERFORM THE PROCEDURE DESCRIBED UNDER POINT A). ANY OTHER USE IS PROHIBITED.

- Open the electrical components compartment.



- Place the emergency key on the electrical components compartment, removing it from the machine's key holder, where it is sealed with lead (see photo).



- Turn the emergency key clockwise and hold it in position (see sticker).

The display on the remote control shows the safety device BYPASS icon.

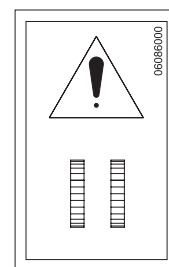
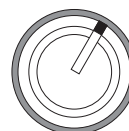
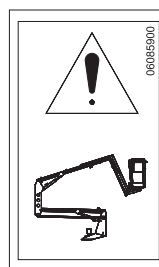
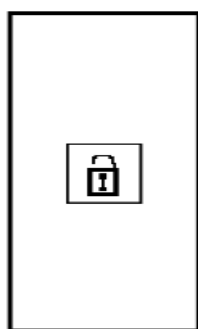

- Use the travel control with extreme care to avoid causing damage to the machine or people.
Move to a suitable position for carrying out procedure A, used to realign the machine.
- At the end of the operation release the key, remove it, put it back in its original position and close the electrical components compartment.
- The electronic control board records every time the safety device bypass key is used.

6.6 ELECTRICAL DISCONNECTION OF THE REMOTE CONTROL



The electrical disconnection/connection of the remote control **MUST** be carried out exclusively with the motor key in position **OFF** and with the mains power disconnected.

- Disconnect the cable from the remote control using the corresponding screw connection.



- Make sure there is no moisture in the remote control connector and close the remote control sealing plug.
- Make sure there is no moisture in the electric cable connector and close the electric cable sealing plug.

NOTE: both connectors must be closed with the respective sealing plugs to prevent moisture from entering.

To reconnect the remote control, follow the same process in the reverse order.

6.7 RECHARGING THE BATTERY

To check the battery charge, always use the special indicator shown on the display on the remote control.

The batteries can be recharged even when using the machine (obviously the recharging times in this case will be longer). The batteries can be recharged even when they are not completely down.

If the charge is less than 20% an audible warning signal will be activated whenever the electric motor is started, to warn the user to charge the machine.

If the charge is less than 10%, in addition to the audible warning signal, reduced speed is activated and an icon comes on in position 4.

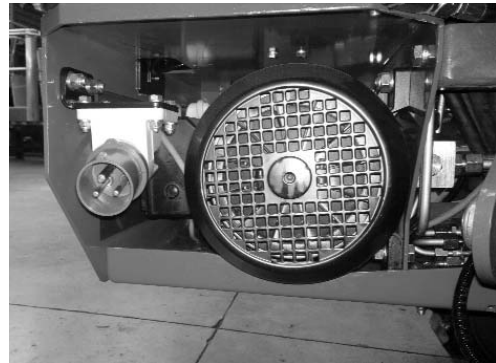

To start recharging the battery simply connect the main power supply to the socket on the right of the undercarriage distributor support and close the circuit breaker.

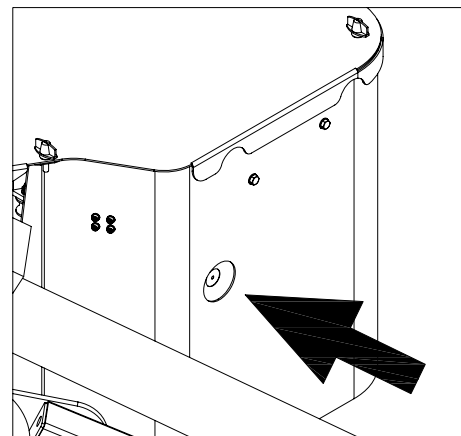

After a few seconds the charge indicator located on the right-hand side of the machine near the battery pack (see figure) turns red, meaning the battery has started recharging.

If the machine is on, the display on the remote control also shows the machine recharge indicator.

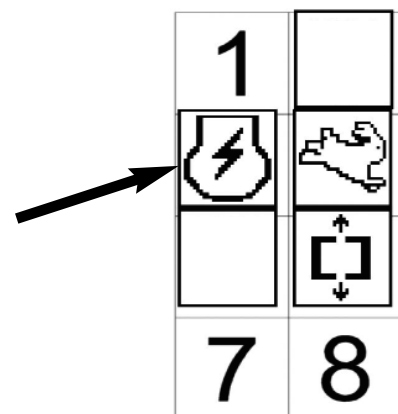

WARNING

The battery charger supplied with the elevating platform was designed to ensure safety and reliable performance. It is already fitted on the machine and does not need any adjustment or configuration by the user; nonetheless, to avoid injury and damage to the battery charger,

the following essential precautions should be observed:

- Carefully read the installation instructions contained in this manual. For future reference, keep the manual in a safe place.
- Do not place the battery charger near sources of heat.
- As the battery charger is sealed and without forced ventilation, its performance depends on the temperature and the type of installation.
- Make sure that the type of power supply available corresponds to the voltage specified and indicated on the battery charger rating plate or in this user and operation manual. In case of doubt, contact your reseller or the local electrical company.
- An AC class circuit breaker can be used as protection device for the battery charger power supply, however it is recommended to use a class A or class B device.
- With regards to safety and electromagnetic compatibility, the battery charger features a three-pin plug with earth, which can only be plugged into an earthed socket. If the plug does not go into the socket, most probably the socket is old and not earthed. In this case, contact an electrician to have the socket replaced.
- Do not use adapters to resolve earth plug problems.
- Make sure the power cable does not represent an obstacle. If the cable is worn or damaged, have it replaced immediately.
- If extensions or multiple sockets are used, make sure that these support the total rated current.
- Disconnect the power supply before connecting or disconnecting the battery.
- The battery charger installed was specially designed to recharge the type of lithium batteries used on the platform. Do not attempt to recharge any other type of batteries.
- Do not attempt to repair the battery charger. Opening the cover may expose the user to the risk of electric shock.
- Do not open the battery charger, opening it may affect the index of protection (IP) even after it has been closed again.
- If the battery charger is not working correctly or is damaged, disconnect it immediately from the power outlet and the battery socket and contact an authorized servicing entity.

Charge curve

The battery charger features just one charge curve (IUIa) plus balancing and maintenance, designed specially for recharging the battery pack of the self-propelled elevating platform.

SELF-PROPELLED TRACKED PLATFORM LL1775

HINOWA

LED Indicator

<i>Colour</i>	<i>Description</i>
Red steady	Current delivered between 12.5 and 25 A
Red flashing	Current delivered between 6 and 12.5 A
Orange steady	Current delivered less than 6 A
Orange flashing (4s ON – 1s OFF)	Standby phase awaiting restart
Orange flashing (1s ON – 1s OFF)	Alarm

TECHNICAL SPECIFICATIONS

T=25°C unless otherwise specified.

Description	Symbol	Test conditions	Value and/or Range	Unit
Single-phase power supply voltage	V_{in}	-	$230 \pm 10\%$	Veff
Frequency	f	-	50 ÷ 60	Hz
Maximum current drawn per phase	$I_{f_{max}}$	$P = P_{max}$	15	Aeff
Initial current peak	-	$V_{in}=230V_{eff}$	< 3	A
Power factor	$\cos\phi$	$P = P_{max}$	0,66	-
Minimum power consumption	$P_{in_{min}}$	End of charge	< 10	W
Maximum power consumption	$P_{in_{max}}$	$P = P_{max}$	2,2	kW
Output current	I	-	25A	A
Output voltage	U	-	48V	V
Maximum power supplied	P_{max}	$U = U1, I = I1$	2000	W
Operating temperature range	ΔT	-	da -20 a +50	°C
Maximum relative humidity	RH	-	90%	-
Switching frequency	f_c	-	$70 \pm 10\%$	kHz
Efficiency	η	Every operating condition	90%	-
Maximum dimensions	a×b×c	Without connection cables	250×220×90	mm



WARNING

Before use, carefully read the instruction booklet.

Make sure that the charge curve selected is suitable for the type of battery being recharged.

6.8 MAIN INTENDED USES OF THE PLATFORM

Below are the specific warnings for the most frequent uses of the machine. The information provided must be considered as an addition to and not a replacement for the contents of the User and Operation manual.

6.8.1 SYSTEMS

Make sure the parts where maintenance is to be performed are not live, if in doubt request verification from personnel on the ground.

Do not operate near power lines.

Keep a suitable distance away based on the voltage (see paragraph "*Risk of electrocution*").

6.8.2 CLOSED ENVIRONMENTS

To perform the operations in closed places the Constructor recommends the use of the machine with the electric engine. If this is not possible, make sure there is enough ventilation to prevent the accumulation of gases that are damaging to the health.

If lighting in the workplace should be insufficient, additional lighting devices must be supplied.

6.8.3 PRUNING

This activity requires very important skills in order to prevent the machine from losing stability. Remember that:

- if branches or logs fall on the safety devices these will be broken;
- falling plant parts may damage the machine;
- falling plant parts may press the emergency button on the ground. In this case the machine cannot be controlled and the personnel on the ground must intervene;
- the tools used for pruning, such as chainsaws, exert considerable force towards the outside of the basket edge;
- it is compulsory to check in advance that the plants being pruned cannot fall on any part of the platform or the basket.

6.8.4 REPAIR AND MAINTENANCE OF ROOFING AND GUTTERS

Remember that it is prohibited to use the platform for the transport of material at a height even if this is within the capacity limits specified by the manufacturer; the MEWP is not a lifting device.

It is also very important to remember that once the basket has been lifted from the chassis it is prohibited to load objects. Remember that no safety device can help if the basket is overloaded at a height. The emergency descent procedure does not prevent overturning. The only way to make things safe is to unload the basket and return as quickly as possible within the allowable limits based on the work configuration.

6.8.5 PAINTING, SAND-BLASTING AND PLASTERING

This type of use requires meticulous protection of the delicate parts of the machine such as hydraulic cylinder rods, gaskets, safety devices, hydraulic telescopic extension arms and markings on the machine (e.g. Rating plate, warning stickers, capacity table etc.). If sand enters the grease protecting the extension arms it produces an extremely abrasive mixture, affecting the quality of the movements and working life of the machine.

6.8.6 USE IN MARINE ENVIRONMENTS

If the machine is used in particularly corrosive environments and atmospheres, the formation of rust and the greasing and lubrication conditions of the moving parts must be checked more frequently than recommended by the manufacturer for normal operating conditions.

It is also good practice to protect the machine carefully every time it is not used, even for short periods, by covering it to shield it against salt and sand carried by the wind.

7. MAINTENANCE

7.1 SAFETY INSTRUCTIONS FOR GREASING AND LUBRICATION



- Errors can be extremely dangerous. Before greasing or making repairs read the user and operation manual carefully.
- Handle all parts with special care. Keep hands and fingers away from concealed spaces, gearing and similar. Always use approved safety devices, such as goggles, gloves and safety footwear.
- Do not dispose of lubricants in the environment but rather collect and dispose of them in compliance with laws in force in the country in question.
- It is prohibited to carry out any maintenance operations with the working arm not completely lowered and/or with stabilised machine.
- If operations are being carried out, apply a visible sign on the control position, stating "DANGER. Do not move the machine, service in progress".

7.2 TABLE OF RECOMMENDED LBRIFICANTS

BRAND	ENGINE OIL	TRANSMISSION OIL	GREASE FOR TURNTABLE AND TENSIONER
PAKELO	SAE 10W30 API CH	EP 150	
AGIP		BLASIA 150	MUEP 1
ESSO		SPARTAN EP 150	BEACON 2

To top up or replace the hydraulic oil **ONLY** use HINOWA oil.

SELF-PROPELLED TRACKED PLATFORM LL1775

HINOWA

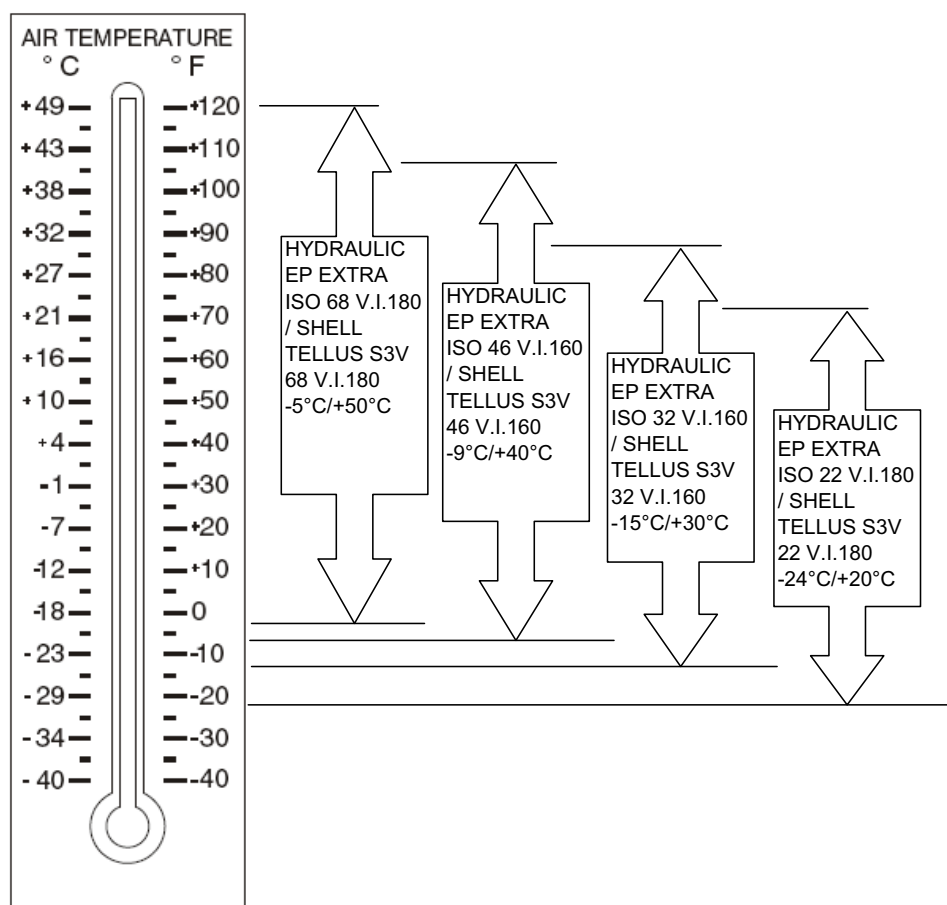

Fluid	Proprieties		Base				Classifications		
	Viscosity at 40°C (cst, Typical)	Viscosity Index	Mineral Oils	Vegetable Oils	Synthetic	Synthetic Polyol Esters	Readily Biodegradable*	Virtually Non-toxic**	Fire Resistant***
Pakelo Hydraulic EP Extra ISO 68	68	180	X						
Pakelo Hydraulic EP Extra ISO 46	46	160	X						
Pakelo Hydraulic EP Extra ISO 32	32	160	X						
Pakelo Hydraulic EP Extra ISO 22	22	180	X						
SHELL TELLUS S3V 68	68	180	X						
SHELL TELLUS S3V 46	46	160	X						
SHELL TELLUS S3V 32	32	160	X						
SHELL TELLUS S3V 22	22	180	X						

* Readily biodegradable classification indicates one of the following: CO₂ Conversion > 60% per EPA 560/6-82-003 / CO₂ Conversion > 80% per CEC-L-33-A-93.

** Virtually Non-toxic classification indicates an LC₅₀ > 5000 per OECD 203.

*** Fire Resistant classification indicates Factory Mutual Research Corp. (FMRC) Approval.

Flash point (C.O.C) for 68-46-32-22: 210°C.

7.3 GREASING POINTS

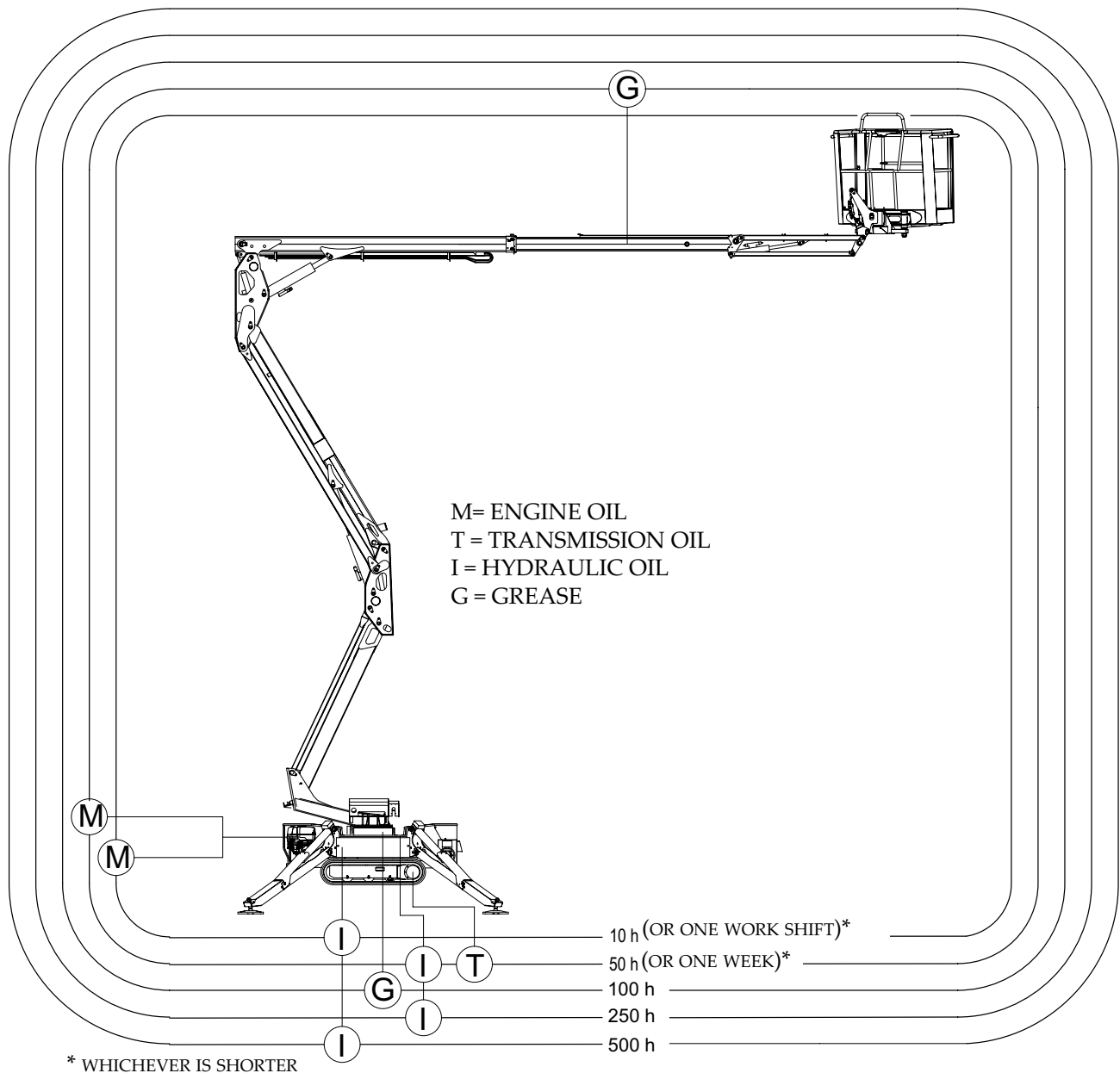

IMPORTANT

RESPECT THE GREASING INTERVALS INDICATED AND USE ONLY THE RECOMMENDED LUBRICANTS IN ORDER TO PROTECT PINS AND CONNECTIONS FROM WEAR.

7.4 GREASING THE TELESCOPIC ARM

Use a brush to apply grease onto the telescopic extension arms.

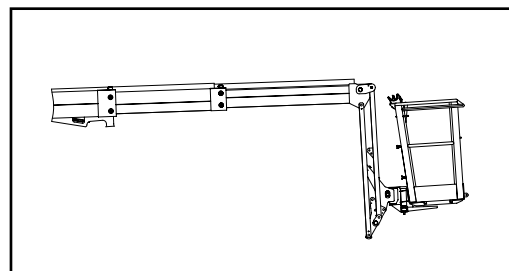

7.5 SAFETY INSTRUCTIONS FOR MAINTENANCE OPERATIONS



- Spare parts must correspond to the technical provisions established by the Constructor. This is guaranteed by the use of original spare parts.
- Errors can be extremely dangerous. Before greasing or making repairs read the user and operation manual carefully.
- Handle all parts with special care. Keep hands and fingers away from concealed spaces, gearing and similar. Always use approved safety devices, such as goggles, gloves and safety footwear.
- When working on the electrical system always wear protective goggles and remove rings, watches and any other metal jewellery. As a general rule, do not use petrol to clean parts.
- Work on the auxiliary electrical system must only be performed by our service department so as to guarantee conformity with the requirements of the standards in force (EN 60204 and national standards).
- Always disconnect the batteries before working on the electrical system.
- Hydraulic hoses must be correctly laid and fitted.
- Tampering with the hydraulic circuit may cause serious danger during use of the platform.
- Do not dispose of lubricants in the environment but rather collect and dispose of them in compliance with laws in force in the country in question.
- Check the vehicle at least once per day or shift for any external damage (corrosion, structural parts, welds). The person in charge must be informed immediately of any change observed (including functional behaviour). In this case, stop the vehicle immediately and carry out more detailed checks.

- Fluid that leaks under pressure may penetrate the skin. Always discharge pressure before removing the hydraulic hoses and tighten connections correctly before pressurising. Keep hands and body away from small holes and nozzles where high-pressure liquids may be released. Use cardboard or paper to identify leaks.



IMPORTANT

Heavy parts must be lifted using a lifting device with suitable capacity.

- It is prohibited to carry out any maintenance operations with the working arm not completely lowered and/or with stabilised machine.
- If operations are being carried out, apply a visible sign on the start panel, stating “**DANGER. Do not move the machine, service in progress**”.

7.6 OPERATING THE MACHINE FROM THE SECOND CONTROL POSITION ON THE GROUND USING THE OPTIONAL SECOND REMOTE CONTROL DURING MAINTENANCE

This type of operation is only allowed in the event of maintenance on the machine by expert personnel.

For the controls from the ground position with the optional second remote control, see the corresponding paragraph.

- Stop the machine, key in the OFF position.
- Withdraw the opening key of the distributor’s controls protection from the lead-covered keys group in the electrical components box;
- Insert the key and open the distributor’s controls protection. Select the ground remote control operating on the relevant selector.
- Connect the optional second remote control following the procedure specified in the corresponding paragraph (make sure the contacts of the connectors on the remote control and the machine are completely dry).
- Start the machine, key in the ON position.
- Check that the icons are correctly shown on the display on the remote control in the ground position.
- Move the aerial part of the machine using the remote control from the ground, following the instructions given in the paragraphs regarding the operation of the machine. If the load in the basket exceeds 50 kg, to use the remote control from the ground hold button 8 and then activate the required movement.

SELF-PROPELLED TRACKED PLATFORM LL1775

HINOWA

7.7 PERIODICAL MAINTENANCE INTERVALS

HONDA PETROL ENGINE

PART	INTERVENTION	BEFORE STARTING	AS NEEDED	INTERVAL (HOURS)						
				10	50	100	250	500	1000	2000
DRY AIR FILTER	CHECK, CLEAN	•								
	CHANGE							•		
ENGINE OIL	CHECK LEVEL	•		•						
	CHANGE				•*		•			
OIL SUMP	CLEAN					•				
FUEL TANK AND NET	CLEAN							•		
HYDRAULIC OIL	CHECK LEVEL	•								
	CHANGE								•	
HYDRAULIC OIL FILTER	CHANGE CARTRIDGE				•*		•			
ARTICULATED JOINT POINTS	GREASE				•*	•				
BATTERY	CHECK ELECTROLYTE LEVEL		•							
REDUCTION GEAR OIL	CHECK LEVEL					•				
	CHANGE				•*				•	
MACHINE	GENERAL PERIODICAL CHECKS								•	•*
EXTENSION ARM INTERNAL SLIDING RING	CHECK WEAR						•			
	CHANGE								•	
TURNTABLE BOLT TIGHTENING	CHECK						•*	•		
NUT FIXING PINS BASKET	CHECK TORQUE 200 Nm								•#	

* First operation.

** At least every 3 months.

*** At least every 5 years.

Anyway every year. If the tightening is not correct replace the nuts with two new with the same specifications and restore the connection without using oil or grease.

SELF-PROPELLED TRACKED PLATFORM LL1775

HINOWA

HATZ DIESEL ENGINE

PART	INTERVENTION	BEFORE STARTING	AS NEEDED	INTERVAL (HOURS)						
				10	50	100	250	500	1000	2000
DRY AIR FILTER	CHECK, CLEAN	•								
	CHANGE							•		
ENGINE OIL	CHECK LEVEL	•		•						
	CHANGE				•*		•			
ENGINE OIL FILTER	CLEAN					•				
	CHANGE							•		
FUEL FILTER	CLEAN	•								
	CHANGE							•		
WATER SEPARATOR	CLEAN AND DRAIN WATER	•			•*		•			
COOLING SYSTEM	CHECK FLUID LEVEL	•								
	TOP UP/CHANGE FLUID							•		
HYDRAULIC OIL	CHECK LEVEL			•						
	CHANGE								•	
HYDRAULIC OIL FILTER	CHANGE CARTRIDGE				•*		•			
ARTICULATED JOINT POINTS	GREASE				•*	•				
BATTERY	CHECK ELECTROLYTE LEVEL		•				•			
REDUCTION GEAR OIL	CHECK LEVEL					•				
	CHANGE						•*		•	
MACHINE	GENERAL PERIODICAL CHECKS								•	•*
EXTENSION ARM INTERNAL SLIDING RING	CHECK WEAR						•			
	CHANGE								•	
TURNTABLE BOLT TIGHTENING	CHECK						•*	•		
NUT FIXING PINS BASKET	CHECK TORQUE 200 Nm								•#	

* First operation.

** At least every 3 months.

*** At least every 5 years.

As regards complete service of the engine, see the manual supplied by the engine manufacturer or download it from the website:

www.honda-engines-eu.com / www.hatz-diesel.com

Anyway every year. If the tightening is not correct replace the nuts with two new with the same specifications and restore the connection without using oil or grease.

7.8 ELECTRIC MOTOR

The electric motor is located inside of the carriage distributor support cover.



7.8.1 ELECTRIC MOTOR MAINTENANCE

Periodically check the condition of the following electric motor components.

- **POWER SUPPLY TERMINALS**

Check tightness of the nuts on the power supply terminals and make sure the insulation is intact.

- **FAN**

Keep air intakes clean and make sure the fan can rotate freely.

- **BEARINGS**

Check the condition of the bearings, in the event of noise contact service department for replacement, as the life of the bearings is reduced significantly in heavy-duty operating conditions.

Note: in the Lithium version the motor is “brushless” therefore no brushes need to be checked or replaced.

7.9 INSPECTION AND MAINTENANCE

All HINOWA aerial platforms must be inspected, tested and serviced according to the following instructions. See the user and operation manual for the complete list of recommended inspection intervals and the correct checking and servicing procedures.

A- DAILY INSPECTIONS BEFORE STARTING

All the components that have a direct influence on the safe operation of the aerial platform and whose conditions may change from day to day must be visually inspected by the operator on a daily basis.

The following must be regularly inspected and must also be checked during operation and between regular inspection intervals:

1. Level of all fluids, such as fuel, engine oil, coolant and battery fluid.
2. Hydraulic hoses for leaks or loose connections.
3. All quick disconnection hoses for proper connection.
4. Structural components for obvious damage, broken parts, and cracks in welds.
5. Ladder or steps for damage and debris (ladders must be firmly secured to the platform).
6. Operating and emergency controls for proper functioning.
7. Placards and warning signs for cleanliness, readability of control signs, rated capacity, and operating manual.
8. Platform assembly for loose and missing parts, missing or loose lock pins and bolts.
9. Platform base for structural damage, holes or cracked welds, dirt, grease, or oil that can create a hazard.
10. Access ways for ease of movement.
11. Protection system operation.
12. Correct operation of the safety devices.
13. Correct operation of elevating, rotating, and drive functions.
14. Brakes.
15. Stabilisers.

B – PERIODICAL INSPECTIONS

These inspections must be performed after 200 h of operation or every month, whichever comes first. The interval between inspections may vary depending on the aerial platform's applications, severity of use, and working environment. Periodical inspections must be performed by a qualified operator.

These inspections must include those described in point A as well as, but not limited to, the following:

1. Loose bolts, nuts, and pins.

2. Hydraulic oil filters for cracks and leaks, pieces of metal on the filter that may cause pump, motor or cylinder malfunction; rubber particles on the filter that may indicate deterioration of hoses, o-rings or other rubber components.
3. Fuel filters.
4. Fan belt adjustment and excessive wear (diesel engine only).
5. Hydraulic hoses for cracks, leaks and buckling, and signs of excessive abrasion on all hoses and pipes.
6. Hydraulic pumps and motors for cracks or leaks, leaks at joints and gaskets, loss of operating speed, excessive heating of fluid, and loss of pressure.
7. Hydraulic cylinders for drifting caused by fluid leaks across the sealing valve or the piston, rod seal leakage, scored and damaged cylinder rods, and unusual noises or vibration.
8. All safety mechanisms for wear and response time.
9. Interlocks, gradient warning system, and limit switches.
10. All chain and cable mechanisms for setting and worn or damaged parts.

C – ANNUAL INSPECTIONS

These inspections must be performed annually.

A complete inspection of the aerial platform must be performed by a qualified operator. The inspection must comply with the requirements of points A and B and must include, but not be limited to, all critical and suspect areas and all accessible structural elements and welds, such as the following:

1. Stabiliser and stabiliser housing (boxes), including the underside of the housing.
2. Platform rotating, elevating, and levelling mechanisms.
3. Main turret rotating mechanism.
4. Brakes.
5. All secured points.
6. Arm sections, pins, cylinder rods, and levelling devices.
7. Switches for wiring and all electrical connections.
8. The constructor's outstanding safety bulletins.

D – STRUCTURAL INSPECTION

A structural inspection is required to verify the structural soundness of critical components of the aerial platform and must be performed:

1. 10 years after the date of manufacture and every 5 years thereafter.
2. after every accident that may actually, presumably, or potentially cause damage and affect the structural soundness or stability of the aerial platform. Such accidents include short circuits, impacts, falls, collisions, or cases of overstress or stability failure.
3. After a change of ownership, unless a complete service history is provided, including

maintenance and inspection records.

The structural inspection must be carried out under the supervision of a professional engineer.

This inspection must:

1. consider the service history of the aerial platform in terms of hours of service, severity of use, and number and variability of users;
2. review the inspection and maintenance record of the aerial platform;
3. verify the efficiency of all operating controls;
4. perform a visual inspection of the aerial platform;
5. consider recommendations of the manufacturer regarding the aerial platform, including manufacturer's safety bulletins.

E – MAINTENANCE

Before adjustments and repairs are started on the aerial platform, the following precautions must be taken:

1. the power system must be stopped, and the starting devices must be rendered inoperative;
2. all controls must be in the OFF position and all operating systems must be secured against accidental activation by brakes, chocks or other means;
3. elevating and rotating assembly and platform must be completely lowered, if possible, or otherwise secured by blocking or propping;
4. the hydraulic oil pressure must be released from all hydraulic circuits before loosening or removing hydraulic components;
5. safety props or latches must be installed where applicable;
6. other precautions must be adopted as specified in the user and operation manual.

7.10 GENERAL PERIODICAL CHECKS

After the first 2000 hours of operation, have a general check run on the machine, at a certified HINOWA service centre, where the general condition of the machine will be assessed and the form in Appendix 1 of this manual will be filled in.

Subsequent checks should be performed every 1000 hours of operation.

To find the nearest certified HINOWA service centre, contact your reseller.

7.11 MAINTENANCE ON THE RUBBER TRACKS

7.11.1 CHECKING THE TRACK TENSION

Stop the machine on solid, level ground. Lift the machine so that it is safe and place stable supports under the undercarriage chassis for total support. Parallel with the central roller of the undercarriage, measure distance A from the bottom of the roller to the rigid inside of the rubber belt. Track tension is normal if the distance A is between 10 and 15 mm.

If the track tension is not within the measurements specified above, that is, it is too loose or too tight, follow the procedures illustrated in the paragraph below.

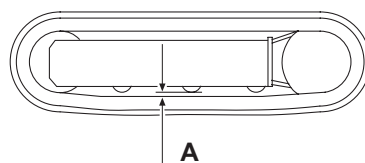

7.11.2 LOOSENING/TIGHTENING THE TRACKS

The grease contained in the hydraulic track is pressurised. For this reason, do not loosen grease nipple 1 more than 1 turn; if the nipple is loosened excessively, it may be expelled due to the pressure of the grease, putting the safety of the operator at risk.

Never loosen grease nipple 2.

When gravel or mud is stuck between the sprocket and the track links, remove it before loosening.

1. Remove the screws and the adjusting mechanism access cover 3.
2. To loosen the track, slowly unscrew valve 1 anticlockwise for no more than one turn. One turn of valve 1 is sufficient to loosen the track.
3. If the grease does not start to come out, turn the track slowly.
4. When the correct track tension has been obtained, turn valve 1 clockwise and tighten it. Remove all traces of grease.

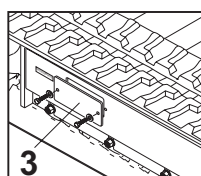
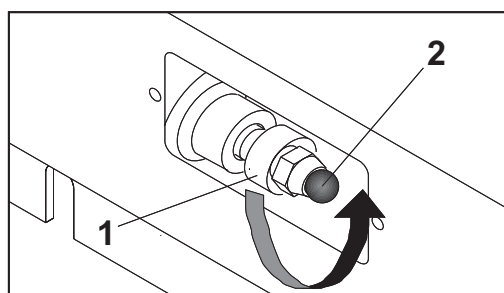

DANGER

5. To tighten the track, connect a grease gun to grease nipple 2 and add grease until tension is within the specified values.



DANGER

It is anomalous if the track remains tightened after the valve 1 has been turned anticlockwise or if the track is still loose after grease has been added to the greaser 2. In any case, do not attempt to remove the tracks or to disassemble the track tensioner cylinder, as the pressure of the grease inside the track tensioner cylinder is very dangerous.

7.11.3 CHECKING THE RUBBER TRACKS

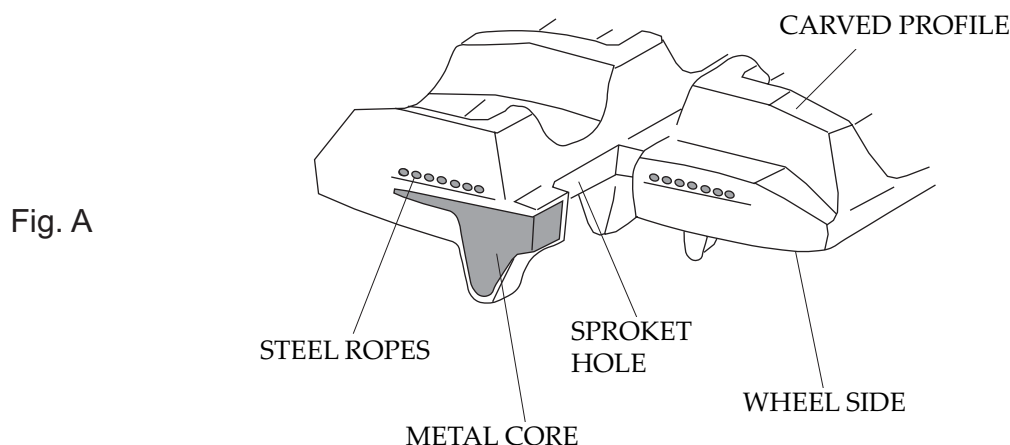

Fig. A

The structure of the rubber track is illustrated in Fig. A. The steel wires and the metal core are buried in the rubber. The pattern provides stability when moving over loose ground. This is on the bottom of the track in contact with the ground, while the guides situated inside the track prevent it from coming off the guide rollers.

Causes of damage

A) *Breakage of the steel wires*

Excessive tension causes the steel wires to break in the following conditions:

- when stones or foreign bodies accumulate between the track and the undercarriage chassis;
- when the track comes off the guides;
- in the event of strong friction, for example in case of abrupt changes in direction.

B) *Wear and breakage of the metal cores*

As for breakage of the steel wires, described above, excessive tension may cause the metal cores to bend or break, as may the following causes:

- incorrect contact between sprocket and track;
- internal breakage of rollers;
- operation on sandy ground.

C) *Separation of the metal cores*

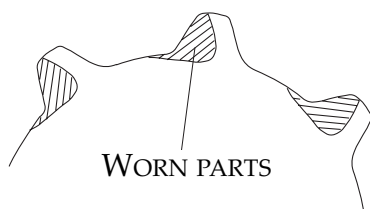

The metal core acts as a sort of adhesive for the rubber between the core itself and the steel wires. Separation may be caused by excessive tension, for the following reasons:

- the metal cores have been wound by the worn sprocket as shown in the figure. When this wear and abrasion is detected, the sprocket must be replaced as soon as possible.

In case of breakage, as described in paragraphs A-B-C, the track must be replaced because this damage leads to a complete loss of functionality.

te loss of functionality.

D) *Abrasion and fatigue cracks*

1. The cracks at the base of the pattern occur due to bending fatigue of the rubber caused by the sprocket and the idler roller.

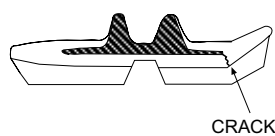

2. The cracks and bends on the rubber edge are due to operations with the track on cement kerbs and edges.

3. The cracks and abrasions in the rubber on the roller guides originate from the compression to which the rubber is subjected due to the weight of the sprocket, as well as from operation on sandy ground, or repeated and abrupt changes in direction.

4. Abrasion of the pattern may occur especially if slewing on concrete surfaces or on gravel or hard surfaces.

The damage indicated in paragraph D points 1, 2, 3 must not be considered critical for the track and, even if in presence of gradual and progressive damage, the track can still continue working.

The damage indicated in point 3 leads to the exposure of the metal cores and if they become exposed for more than half of the circumference of the track, it is time to replace them. The track however can still be used.

E) *Cracks due to external factors*

Cracks on external track surfaces (those in contact with the ground) are often due to contact with gravel, sharp stones, sharp materials, nails, glass, which cause cuts. From the point of view of the rubber's properties, this is inevitable although it does depend on service conditions.

Cracks on the internal surface of the circumference and on the edge of the rubber originate from contact of the track with the structure of the undercarriage or with sharp concrete edges. The increase in crack severity is relatively small. Even if it does not appear to be in good conditions, the track can be used for heavy-duty applications.

7.11.4 CHANGING THE RUBBER TRACKS



DANGER

The grease contained in the hydraulic track is pressurised. For this reason, do not loosen grease nipple 1 more than 1 turn; if the nipple is loosened excessively, it may be expelled due to the pressure of the grease, putting the safety of the operator at risk.

Never loosen grease nipple 2.

When gravel or mud is stuck between the sprocket and the track links, remove it before loosening.

Removing the rubber track

1. Stop the machine on solid and level ground, lift it and support it in safe conditions, using the stabilisers.

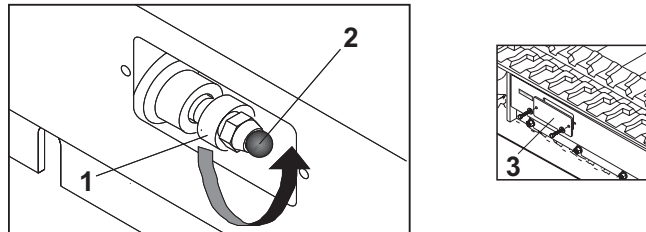

2. Remove the screws and the adjusting mechanism access cover 3.
3. To loosen the track, slowly unscrew valve 1 anticlockwise giving no more than one turn. One turn of valve 1 is sufficient to loosen the track.
4. If the grease does not start to come out, turn the track slowly.
5. Insert 3 steel pipes (4) inside the track in the space between the rollers. Turn the sprocket backwards (5) so that the steel pipes move with the track and engage the idler roller. Force laterally (6) to make the track slide and lift it from the idler roller.

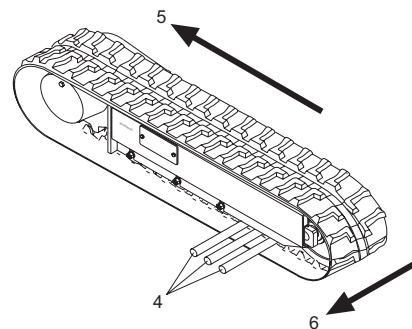

Fitting the rubber track



DANGER

1. Before fitting the tracks, make sure that the machine is lifted and in safe conditions.
2. Check that the grease in the hydraulic cylinder has been removed.
3. Engage the track links with the sprocket and position the other end of the track on the

idler roller.

4. Turn the sprocket in reverse (7) pushing the track shoes inside the chassis (8).
5. Position the track using a steel pipe and turn the sprocket again.
6. Ensure that the track links are correctly engaged in the sprocket and in the idler roller.
7. Adjust the track tension.
8. Rest the undercarriage on the ground.

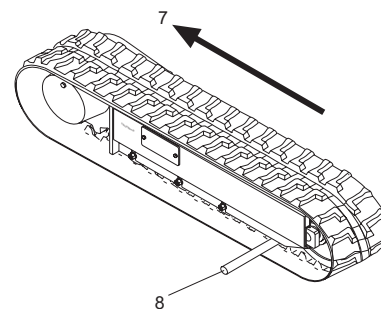

7.12 CHECKING TIGHTNESS OF NUTS AND BOLTS

Depending on the use of the platform, it is essential to check the parts and the nuts and bolts which are subject to loosening.

Pay particular attention to the chassis components, such as idler roller, travel gear motors, sprockets and guide rollers. Check that they are tightened sufficiently, according to the following table.

The values indicated are to be applied unless different instructions are given in this manual.

SELF-PROPELLED TRACKED PLATFORM LL1775

HINOWA

Values for Zinc Yellow Chromate Fasteners (Ref 4150707)																					
SAE GRADE 5 BOLTS & GRADE 2 NUTS																					
Size	TPI	Bolt Dia	Tensile Stress Area	Clamp Load	Torque (Dry)		Torque Lubricated		Torque (Loctite® 242™ or 271™ OR Vibra-TITE™ 111 or 140)		Torque (Loctite® 262™ or Vibra-TITE™ 131)		Clamp Load		Torque (Dry or Loctite® 263 K= 0.20)		Torque (Loctite® 242™ or 271™ OR Vibra-TITE™ 111 or 140)		Torque (Loctite® 262™ or Vibra-TITE™ 131) K=0.15		
					IN-LB	IN-LB	IN-LB	IN-LB	IN-LB	IN-LB	IN-LB	IN-LB	IN-LB	IN-LB	IN-LB	IN-LB	IN-LB	IN-LB	IN-LB	IN-LB	IN-LB
4	40	0.1120	0.00604	360	8	0.9	6	0.7													
48	48	0.1120	0.00661	420	9	1.0	7	0.8													
6	32	0.1380	0.00909	560	16	1.8	12	1.4													
8	40	0.1380	0.01015	610	18	2.0	13	1.5													
8	32	0.1640	0.01400	900	30	3.4	22	2.5													
36	36	0.1640	0.01474	940	31	3.5	23	2.6													
24	24	0.1900	0.01750	1120	43	4.8	32	3.5													
32	32	0.1900	0.02000	1285	49	5.5	36	4													
1/4	20	0.2500	0.0318	2020	96	10.8	75	9	105	12	105	12	15	2860	143	16	129	15			
28	28	0.2500	0.0364	2320	120	13.5	86	10	135	15	135	15	17	3280	164	19	148	17			
5/16	18	0.3125	0.0524	3340	17	23	13	18	19	26	16	22	35	4720	25	35	20	25			
24	24	0.3125	0.0680	3700	19	26	14	19	21	29	17	23	35	5220	25	35	20	25			
3/8	16	0.3750	0.0775	4940	30	41	23	31	35	48	28	38	45	7000	45	60	40	55			
24	24	0.3750	0.0878	5600	35	47	25	34	40	54	32	43	7000	50	70	45	60	35			
7/16	14	0.4375	0.1063	6800	50	68	35	47	55	75	45	61	9550	70	95	65	90	50			
20	20	0.4375	0.1187	7550	55	75	40	54	60	82	50	68	10700	80	110	70	95	60			
1/2	13	0.5000	0.1419	9050	75	102	55	75	85	116	68	92	12750	105	145	95	130	80			
20	20	0.5000	0.1599	10700	90	122	65	88	100	136	80	108	14400	120	165	110	150	90			
9/16	12	0.5625	0.1820	11600	110	149	80	108	120	163	98	133	16400	155	210	140	190	115			
18	18	0.5625	0.2030	12950	120	163	90	122	135	184	109	148	18250	170	230	155	210	130			
5/8	11	0.6250	0.2260	14400	150	203	110	149	165	224	135	183	20350	210	285	190	260	160			
18	18	0.6250	0.2560	16300	170	230	130	176	190	258	153	207	23000	240	325	215	290	180			
3/4	10	0.7500	0.3340	21300	260	353	200	298	285	388	240	325	30100	375	510	340	460	280			
16	16	0.7500	0.3730	23800	300	407	220	298	330	449	268	363	33600	420	570	380	515	315			
7/8	9	0.8750	0.4620	29400	430	583	320	434	475	646	386	523	41600	605	825	545	740	455			
14	14	0.8750	0.5090	32400	470	637	350	475	520	707	425	576	45800	670	910	600	815	500			
8	8	1.0000	0.6060	38600	640	868	480	651	719	918	579	785	51500	860	1170	770	1045	680			
12	12	1.0000	0.6630	42200	700	949	530	719	735	1000	633	858	59700	985	1355	895	1215	745			
1 1/8	7	1.1250	0.7630	42300	800	1085	600	813	840	1142	714	968	68700	1290	1755	1160	1580	965			
12	12	1.1250	0.8560	47500	880	1193	660	895	925	1258	802	1087	77000	1445	1965	1300	1770	1085			
1 1/4	7	1.2500	0.9690	53800	1120	1518	840	1139	1175	1598	1009	1368	87200	1815	2470	1635	2225	1365			
12	12	1.2500	1.0730	59600	1240	1681	920	1247	1300	1768	1118	1516	96600	2015	2740	1810	2460	1510			
1 3/8	6	1.3750	1.1650	64100	1460	1979	1100	1491	1525	2074	1322	1792	104000	2385	3245	2145	2915	1785			
12	12	1.3750	1.3150	73000	1680	2278	1260	1708	1750	2380	1506	2042	118100	2705	3680	2435	3310	2030			
1 1/2	6	1.5000	1.4050	78000	1940	2630	1460	1979	2025	2754	1755	2379	126500	3165	4305	2845	3870	2370			
12	12	1.5000	1.5800	87700	2200	2983	1640	2224	2300	3128	1974	2676	142200	3555	4835	3200	4350	2665			

NOTES: 1. THESE TORQUE VALUES DO NOT APPLY TO CADMIUM PLATED FASTENERS
 2. ALL TORQUE VALUES ARE STATIC TORQUE MEASURED PER STANDARD AUDIT METHODS TOLERANCE = ±10%
 3. * ASSEMBLY USES HARDENED WASHER

Torque Specs

SELF-PROPELLED TRACKED PLATFORM LL1775

HINOWA

SOCKET HEAD CAP SCREWS																	
Magni Coating (Ref 4150701)*						Zinc Yellow Chromate Fasteners (Ref 4150707)*											
Size	TPI	Bolt Dia	Tensile Stress Area	Clamp Load See Note 4	Torque (Dry) K = .17		Torque (Locitte® 242™ or 271™ OR Vibra-TITE™, 111 or 140 OR Precoat 85® K=0.16)		Torque (Locitte® 262™ or Vibra-TITE™, 131) K=0.15		Clamp Load See Note 4	Torque (Dry) K = .20		Torque (Locitte® 242™ or 271™ OR Vibra-TITE™, 111 or 140 OR Precoat 85® K=0.18)		Torque (Locitte® 262™ or Vibra-TITE™, 131) K=0.15	
					IN-LB	[N.m]	IN-LB	[N.m]	IN-LB	[N.m]		IN-LB	[N.m]	IN-LB	[N.m]		IN-LB
4	40	0.1120	0.00604	LB													
	48	0.1120	0.00661														
6	32	0.1380	0.00909														
	40	0.1380	0.01015														
8	32	0.1640	0.01400														
	36	0.1640	0.01474														
10	24	0.1900	0.01750														
	32	0.1900	0.02000														
1/4	20	0.2500	0.0318	2860	122	14	114	13			2860	143	16	129	15		
	28	0.2500	0.0364	3280	139	16	131	15			3280	164	19	148	17		
		In	Sq In	LB	FT-LB	IN-LB	[N.m]	FT-LB	[N.m]	IN-LB	[N.m]	FT-LB	[N.m]	IN-LB	[N.m]	FT-LB	[N.m]
5/16	18	0.3125	0.0524	4720	20	25	20	25	20	25	4720	25	35	20	25	20	25
	24	0.3125	0.0580	5220	25	35	20	25	20	25	5220	25	35	20	25	20	25
3/8	16	0.3750	0.0775	7000	35	50	35	50	35	50	7000	45	60	40	55	35	50
	24	0.3750	0.0878	7900	40	55	40	55	35	50	7900	50	70	45	60	35	50
7/16	14	0.4375	0.1063	9550	60	80	55	75	50	70	9550	70	95	65	90	50	70
	20	0.4375	0.1187	10700	65	90	60	80	60	80	10700	80	110	70	95	60	80
1/2	13	0.5000	0.1419	12750	90	120	85	115	80	110	12750	105	145	95	130	80	110
	20	0.5000	0.1599	14400	100	135	95	130	90	120	14400	120	165	110	150	90	120
9/16	12	0.5625	0.1820	16400	130	175	125	170	115	155	16400	155	210	140	190	115	155
	18	0.5625	0.2030	18250	145	195	135	185	130	175	18250	170	230	155	210	130	175
5/8	11	0.6250	0.2260	20350	180	245	170	230	160	220	20350	210	285	190	260	160	220
	18	0.6250	0.2560	23000	205	280	190	260	180	245	23000	240	325	215	290	180	245
3/4	10	0.7500	0.3340	30100	320	435	300	400	280	380	30100	375	510	340	460	280	380
	16	0.7500	0.3730	33600	355	485	335	455	315	430	33600	420	570	380	515	315	430
7/8	9	0.8750	0.4620	41600	515	700	485	660	455	620	41600	605	825	545	740	455	620
	14	0.8750	0.5090	45800	570	775	535	730	500	680	45800	670	910	600	815	500	680
1	8	1.0000	0.6060	51500	730	995	685	930	645	875	51500	860	1170	775	1055	645	875
	12	1.0000	0.6630	59700	845	1150	795	1080	745	1015	59700	995	1355	895	1215	745	1015
1 1/8	7	1.1250	0.7630	68700	1095	1490	1030	1400	965	1310	68700	1290	1755	1160	1580	965	1310
	12	1.1250	0.8560	77000	1225	1665	1155	1570	1085	1475	77000	1445	1965	1300	1770	1085	1475
1 1/4	7	1.2500	0.9690	87200	1545	2100	1455	1980	1365	1855	87200	1815	2470	1635	2225	1365	1855
	12	1.2500	1.0730	96600	1710	2325	1610	2190	1510	2055	96600	2015	2740	1810	2460	1510	2055
1 3/8	6	1.3750	1.1550	104000	2025	2755	1905	2590	1785	2430	104000	2385	3245	2145	2915	1785	2430
	12	1.3750	1.3150	118100	2300	3130	2165	2945	2030	2760	118100	2705	3680	2435	3310	2030	2760
1 1/2	6	1.5000	1.4050	126500	2690	3660	2530	3440	2370	3225	126500	3165	4305	2845	3870	2370	3225
	12	1.5000	1.5800	142200	3020	4105	2845	3870	2665	3625	142200	3555	4835	3200	4350	2665	3625

NOTES: 1. THESE TORQUE VALUES DO NOT APPLY TO CADMIUM PLATED FASTENERS
 2. ALL TORQUE VALUES ARE STATIC TORQUE MEASURED PER STANDARD AUDIT METHODS TOLERANCE = ±10%
 *3. ASSEMBLY USES HARDENED WASHER OR FASTENER IS PLACED AGAINST PLATED STEEL OR RAW ALUMINUM
 4. CLAMP LOAD LISTED FOR SHCS IS SAME AS GRADE 8 OR CLASS 10.9 AND DOES NOT REPRESENT FULL STRENGTH CAPABILITY OF SHCS. IF HIGHER LOAD IS REQUIRED, ADDITIONAL TESTING IS REQUIRED.

Torque Specs

7.13 CHECKING THE HYDRAULIC OIL LEVEL

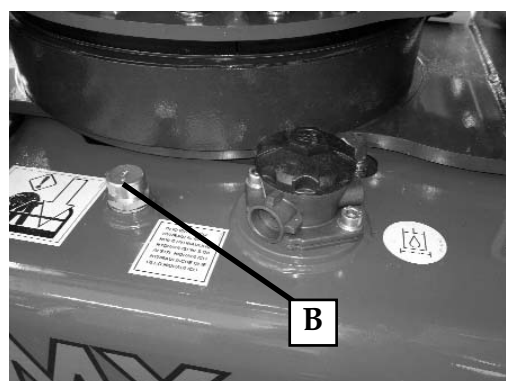
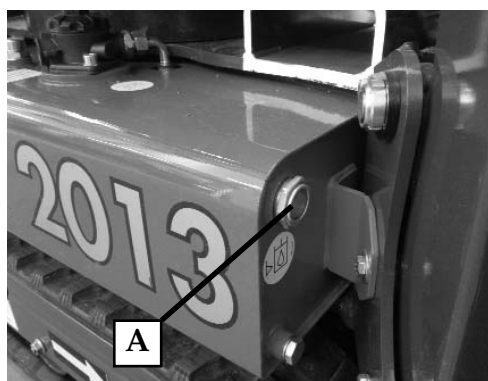

The check must be carried out with the platform (EWP) and the stabilisers in the resting position on flat ground.

Check the oil level on indicator A; the oil must be half way up the level indicator.

If this is not the case, top up through cap B.

7.13.1 HYDRAULIC OIL

For top-up or replacement of hydraulic oil **ONLY** use HINOWA oil.

7.14 CHECKING FOR LEAKS IN THE HYDRAULIC SYSTEM

Visually check all hoses, connections and all other components in the hydraulic system, in order to identify any possible leaks.

Leaks from hoses can normally be resolved by tightening the fittings.

Leaks from gaskets (O rings, sealing rings etc.) cannot be eliminated by simply tightening, as gaskets usually leak because they are damaged or have become hard.

The correct tightness can only be restored by replacing the gasket.

7.15 CHECKING THE CONDITION OF THE FILTER CARTRIDGE

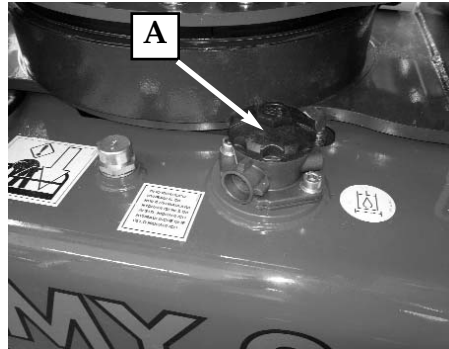

The cartridge must be replaced on every oil change and according to the intervals specified in the maintenance table.

NOTE: it is very important to replace the cartridge for the first time after 50 operating hours, to eliminate hose and hydraulic component processing residues from the hydraulic system.

1. Unscrew the cap A and remove the filter cartridge.
2. If it is very dirty, replace it with a new one having the same characteristics.
3. Tighten cap A.

7.16 CHECKING THAT ALL THE PLATES ARE PRESENT ON THE MACHINE AND INTACT

- Make sure that the prohibition, warning, danger and control plates positioned on the machine are all present and visible.
- See the paragraph regarding pictograms, to identify any missing or damaged plates.

7.17 CHECKING THE OPERATING PRESSURES IN THE HYDRAULIC SYSTEM

A pressure gauge, with a minimum scale of 250 bars, must be used to carry out this check.



- Make sure that the machine is closed and in the resting position.
 - Make sure that no one is standing within the machine operating range.
 - All the specified checks must be carried out from the control position in the basket.
- a) Connect the pressure gauge to the pressure intake on the aluminium delivery manifold block located in the proportional valve compartment (see photo).
First connect fitting upper pressure intake.



- b) Go to the control position and switch the machine on.
- c) Close one of the two right stabilisers completely and maintain the movement activated.
Read the pressure value. This value relates to the right track distributor.
Switch the machine off.
- d) Connect the pressure gauge to fitting lower pressure intake.
- e) Go to the control position and switch the machine on.
- f) Close one of the two left stabilisers completely and maintain the movement activated.
Read the pressure value. This value relates to the left track distributor.
- g) Stabilise the machine.
- h) Set the second arm cylinder to the FOLDING mode.
Keep the joystick in position.
Read the pressure value. This value relates to the aerial part distributor.

7.18 CHECKING TIGHTNESS OF THE FASTENING SCREWS ON THE PIN RETAINERS AND THE LOCK NUTS

- Check that the fastening screws on the pin retainers and lock nuts are not loose.
- If they have become loose, tighten the bolts or the lock nuts, as specified in the paragraph "*Pin locking bolts and nuts*".

7.19 CHECKING WEAR ON THE EXTENSION ARM INTERNAL SLIDING RING



It is important to check the wear on the extension arm internal sliding ring secured to the end of the extension arm cylinder, observing the schedule indicated in the Routine maintenance table. If the wear on the radius of the ring exceeds 3 mm, it must be replaced.

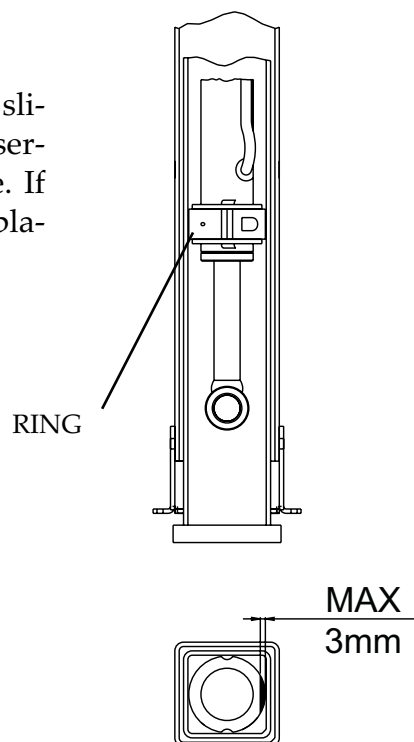

7.20 CHECKING WEAR ON THE TELESCOPIC ARM SLIDES

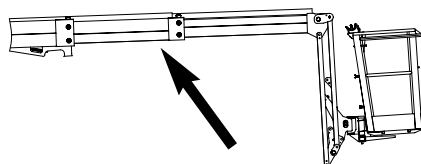

- visually check the play on the extension arms.
- if the play exceeds 3 mm, adjust the plastic registers by screwing them tighter until they rest on the arm (top) or reach around 1 mm from the arm (bottom). Check correct contact and distances by sliding the arm out and back completely.
- the slides must be replaced, where necessary, by an HINOWA authorised workshop.

7.21 CHECKING TIGHTNESS OF THE TURNTABLE BOLTS

Check the correct tightness of the top and bottom bolts on the turntable according to the intervals specified in the routine maintenance table.

The bolts must be tightened to a torque of 248 Nm.

7.22 BATTERY: CHECKS AND MAINTENANCE THERMIC VERSION



- Do not use naked flames or produce sparks near the battery (explosive gases).
- The battery contains diluted sulphuric acid, which is highly explosive.
- Proceed with care, shielding your eyes and face.
- In case of accidental contact with the sulphuric acid, rinse immediately with plenty of running water.
- Before working on the battery, ALWAYS disconnect the battery cutout switch.

7.22.1 CHECKING THE ELECTROLYTE LEVEL THERMIC VERSION

The battery does not need to be topped up.

However, if the electrolyte, with the machine on a level surface, is below the minimum allowed level (MIN.), it is possible to top up by removing the lid "A" and adding distilled water without exceeding the maximum level (MAX.). Only for no AGM technology battery (Absorbed Glass Mat)

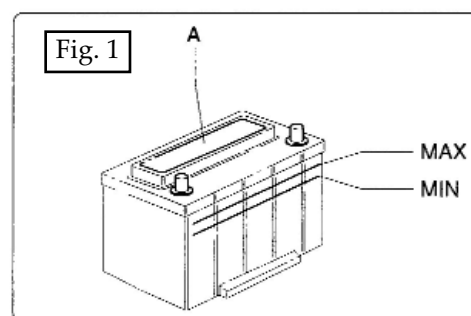

If the machine is going to remain unused for more than one month, it is advisable to insulate the battery:

- Disconnect the battery terminals, always starting from the negative pole (-).
- Reconnect the cables, always starting from the positive pole (+).

7.22.2 RECHARGING THE BATTERY THERMIC VERSION



- The battery must be recharged in well ventilated places, away from naked flames and possible sources of sparks.
- Do not disconnect the cables with the engine running.
- The machine is equipped with an internal battery charger. To recharge the battery, connect the machine to the mains power supply and press the corresponding switch (photo).



WARNING

Before connecting the machine to the mains power supply.



- Make sure that the battery cutout switch is not disconnected.

Alternatively, it is possible to recharge the battery by proceeding as follows:

- 1) Disconnect the terminals of the machine's electrical system from the battery poles.
- 2) Remove the lid "A" (Figure 1).
- 3) Connect the cables of the battery charger to the battery poles and switch the recharger on.
- 4) Once the charge has been completed, switch the device off before disconnecting it from the battery.
- 5) Fasten the terminals to the battery poles, then protect them with a layer of pure vaseline or another suitable substance.
- 6) Close the battery with the lid "A" (Figure 1).



The charging voltage must never exceed 14.7 Volts and the charge intensity must always be limited to 0.2% of the value indicated on the lid.

7.22.3 REPLACING THE BATTERY THERMIC VERSION



- Do not disconnect the cables with the engine running.
- Before disconnecting the cables, turn the engine key to position OFF.
- Disconnect the battery terminals, always starting from the negative pole (-).
- Reconnect the cables, always starting from the positive pole (+).

When the battery cannot accumulate electric energy any longer, replace it with a new one having the same characteristics.

See the specifications table on the battery.

7.22.4 BATTERY DISPOSAL

The batteries must be disposed of in compliance with the specific regulations in force.

7.23 BATTERY PACK OPERATING SPECIFICATIONS

The battery pack must be used and handled with care to ensure safe operation and maximum machine performance.

The battery pack has a rated voltage of 48 Vdc; any modifications made by unauthorised personnel invalidate the warranty and may cause damage to the machine and harm to people and things.

Only qualified personnel are authorised to handle and access the battery pack.

The battery pack is made up of just one module positioned at the rear of the machine. The weight of the battery pack is approximately 80 kg.

In case of problems, only authorized personnel are authorised to access the battery pack and replace it.

Additional electronic devices may have a negative influence on the correct operation of the electronic components provided on the machine. For this reason it is absolutely forbidden to use any devices on the vehicle that do not comply with directive 72/245/EEC and its subsequent amendments (2005/49/EC, 2005/83/EC, 2006/28/EC).

The constructor accepts no liability for any damage due to failure to comply with this warning.



WARNING

Opening and handling the battery pack is dangerous. Failure to observe this warning automatically voids the warranty.

NEVER OPEN THE BATTERY PACK

The battery pack works at peak performance and in safe conditions with an ambient temperature between -20°C and 40°C. Using the battery pack out of this temperature range may be dangerous.

Avoid leaving the machine in sunny and badly ventilated places for long periods.

The battery pack is connected to the motor control via a 100 A fuse.

The fuse may be replaced only by qualified personnel.

Always keep the battery charged. Recharge the battery pack whenever considered necessary, even if the battery has not completely run down.

To check the battery level use the special indicator provided. The battery level depends on many factors, for this reason, to avoid incorrect reading of the indicator, always keep the batteries charged. If the machine is not used for extended periods, recharge at least every 3 months.

7.23.1 COMPONENTS AND DIAGRAMS

BATTERIES

The battery pack must be used and handled with care to ensure safe operation and maximum machine performance.

The battery pack has a rated voltage of 48 Vdc; any modifications made by unauthorised personnel invalidate the warranty and may cause damage to the machine and harm to people and things.

Only HINOWA technical personnel are authorised to handle and access the battery pack.

The battery pack is made up of just one module positioned at the rear of the machine. The weight of the battery pack is approximately 80 kg.

BATTERY REPLACEMENT & MAINTENANCE



WARNING

In case of problems, only qualified personnel are authorised to access the battery pack and replace it.

RECHARGING

Recharge the Battery System only using the special battery charger provided with the machine.

Using a different battery charger may cause damage to the machine and pose a risk to the operator.

Do not remove the cover and do not tamper with the battery charger.

Failure to observe these rules voids the machine's warranty, may affect the correct operation of the battery system and may cause damage to things and people.

Recharge the machine in a ventilated and dry place, at an external temperature not exceeding 40°C and not below 0°C.

Always supervise the machine when recharging.

To recharge the machine, proceed as follows:

- Connect the main power cable (220V ~) to the socket on the side of the undercarriage distributor support.

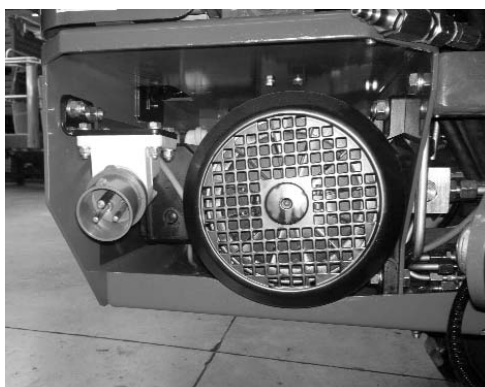

EXPLODED DIAGRAM OF SYSTEM COMPONENTS

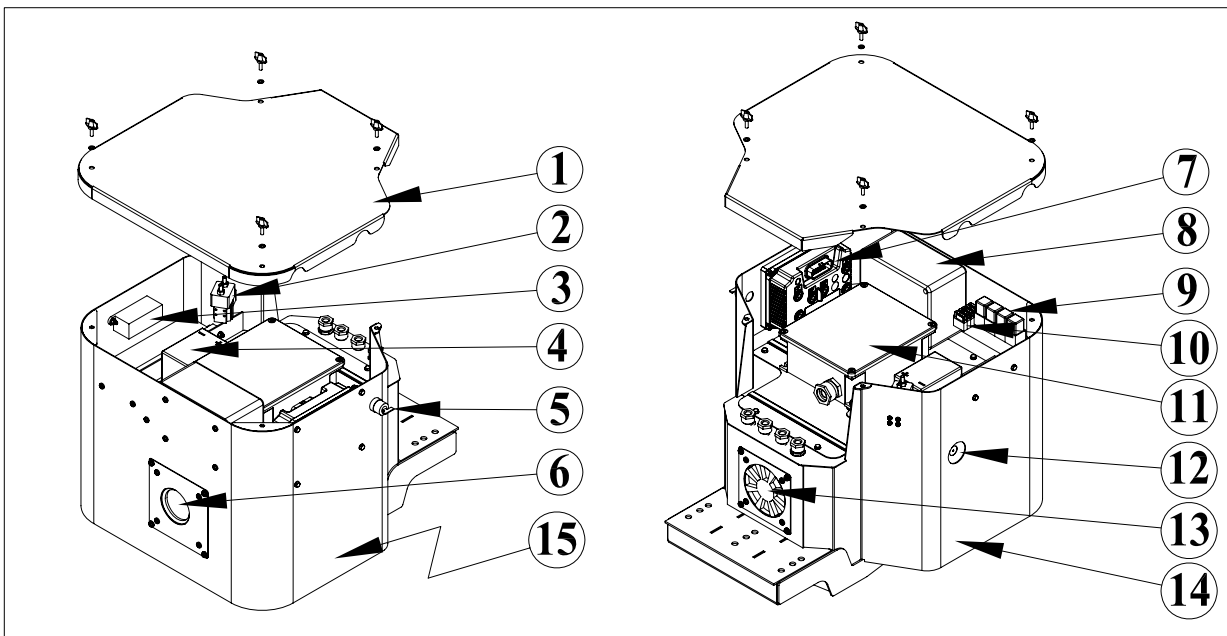

- 1) Battery case cover
- 2) Remote control switch
- 3) 100A 48V fuse
- 4) 12V 12Ah battery
- 5) Starter
- 6) Suction fan
- 7) Inverter
- 8) 48V/12V DC/DC
- 9) Relay
- 10) Fuses
- 11) Battery management system
- 12) Battery charge indicator
- 13) Blower fan
- 14) Battery case
- 15) 15 cells (90Ah)

7.23.2 PERSONAL PROTECTIVE EQUIPMENT

When recharging the battery pack and during any other maintenance operation on the battery pack, it is necessary to use at least the Personal Protective Equipment (PPE) listed below.



Eye protection devices

Protective glasses in accordance with EN 166, for protection against sprays of hazardous materials.



Hand protection devices

Hand protection gloves in accordance with EN 60903, for protection and insulation during work on live parts.



Foot protection devices

Shoes with antistatic coating able to insulate the worker during work on the electrical parts of the system.

7.23.3 HANDLING IN DANGEROUS CONDITIONS

The battery cells must be handled correctly in order to ensure proper and safe use. However, if mistakes are made in handling the cells, causing explosion or venting, the user has to be equipped so as to be able to face this emergency. The aim of this section is to adequately train the user on safe handling of the cells that have been subjected to extreme conditions.

These conditions are as follows:

1. Hot cells
2. Cells that have released substances or vented
3. Exploded cells
4. Fire enveloping the lithium batteries

7.23.3.1 PROCEDURE FOR HANDLING HOT CELLS

As soon as it has been established that the temperature of a cell has risen considerably, the first action is the evacuation of personnel from the affected area. The area has to be isolated and nobody can enter if not strictly necessary.

If possible, before leaving the area, the person who first identified the problem has to check if there is an external short-circuit and resolve it as soon as possible. After the short-circuit has been resolved, the cell will start to cool down. However, the area has to remain isolated until the cell reaches ambient temperature and is removed from the area. The temperature of the cell has to be checked periodically using a remote sensor such as an infrared sensor. If the cell remains hot the following actions must be assessed.

- ***Minimum equipment required:***

- Infrared temperature probe
- Safety glasses
- Hard hat with impact resistant face visor
- Non-conductive pliers
- Hand, arm and body protection

- ***Procedure***

- Evacuate the area as soon as abnormal cell temperature has been established.
- Periodically check the temperature of the cell using a remote sensor for the first two hours or until one of the following cases occur:
 - ▶ The cell starts to cool down
 - ▶ The cell vents
 - ▶ The cell explodes
- If the cell starts cooling, check the temperature every hour until ambient temperature has been reached.
- If a temperature sensor is not available, do not handle the cell for a minimum of 24 hours.
- Remove the cell from the work area when ambient temperature has been reached and return to normal operations.
- Dispose of the cell in accordance with existing legislation (in the country in question) on hazardous goods.
- The procedures in cases of venting or explosion are examined in the following paragraphs.

7.23.3.2 PROCEDURE FOR HANDLING VENTED CELLS

In normal conditions a cell does not show leaks or venting, however a cell may vent or release substances if the critical temperature is reached or if the protective glass-metal seal breaks due to severe mechanical conditions.

The severity of the leak consequent to venting ranges from slight leak around the seal to a violent leak of substances through the vent. In some cases, if the cell is not plugged, it may behave as a projectile.

The electrolyte inside the cell may cause very serious irritation to the respiratory tract, eyes and skin. In addition, venting may cause the emission of highly corrosive vapours in the work environment. In this case, all protective equipment suited to limit exposure to toxic fumes must be available.

- *Minimum equipment required*

- Class D fire extinguisher
- Eye protection or face shield
- Respirator with filter for hydrochloric acid and sulphur dioxide
- Neoprene gloves
- Acid-resistant lab coats
- Baking soda, calcium oxide or acid absorbent in kit form
- Vermiculite
- Plastic bags

- *Procedure*

In the event of electrolyte release from the cells, proceed as follows:

- Evacuate the people exposed to fumes from the area.
- Air the environment until the complete removal of the cell and until the characteristic pungent odour has disappeared.
- If the cell is too hot, allow it to cool to ambient temperature before handling it.
- Wear safety equipment: coat, gloves, mask and filters, and move the cell to a well-ventilated area.
- Place every cell in a sealable plastic bag and remove the excess air, then seal the bag.
- Place a cup of vermiculite in a second bag, place the first bag in the second and seal it.
- Place everything in a third bag with some soda and seal the bag.
- Absorb and collect the leaked electrolyte with absorbent material or soda.
- Place the absorbent material in a bag and seal it.
- Clean the area with plenty of water.
- Dispose of the hazardous material in accordance with the local legislation in force.

- *First aid in the event of contact with the electrolyte*

EYES

Immediately wash the eyes in abundant running water for at least 15 minutes, keeping the eyelids open and flushing the eye and back of the eyelid. Immediately seek medical help.

SKIN

Wash in cold water under a shower, remove contaminated garments. Continue washing for at least 15 minutes. Seek medical help where necessary.

RESPIRATORY TRACT

Move the casualty outdoors into the open air. If the casualty has difficulty breathing, have oxygen administered by trained personnel. If breathing stops, apply mouth-to-mouth resuscitation and immediately seek emergency medical help.

7.23.3.3 PROCEDURE FOR EXPLODED CELLS

The explosion of lithium batteries is not likely, it is a rare event that only occurs when an abnormal condition causes the temperature to rise and reach a critical point. However, in the event of lithium battery explosion the environment will quickly be filled with dense white smoke which will cause serious irritation to the respiratory tract, eyes and skin. Precautions must be taken to limit exposure to these fumes.

- *Minimum equipment required*

- Class D fire extinguisher
- Class ABC extinguisher for any secondary fires
- Eye protection or face shield
- Respirator with filter for hydrochloric acid and sulphur dioxide
- Neoprene gloves
- Acid-resistant lab coats
- Baking soda, calcium oxide or acid absorbent in kit form
- Vermiculite
- Plastic bags

- *Procedure*

In the event of cell explosion, proceed as follows:

- Evacuate personnel from the areas contaminated by smoke.
- Ventilate the rooms until the cell has been removed from the area and until the characteristic pungent odour has disappeared.
- Even if this is quite unlikely, there may be fires as a consequence of the explosion. The ways these emergencies are faced are described in the following paragraph.
- The exploded cell may be hot. Allow it to cool down to ambient temperature before handling it (see *Procedure for handling hot cells*).
- Wear safety equipment: coat, gloves, mask and filters.
- In case of explosion the area around the cell will be covered by a black carbonaceous material which contains metallic parts of the cell. Cover the carbonaceous residues with a 50/50 mixture of soda and vermiculite or other absorbent material. Avoid contact between the metallic residues and charged cells, as this condition may cause a short-circuit.

HINOWA

- Place the contaminated material in a sealable plastic bag and remove the excess air. Seal the bag.
- Place a cup of vermiculite in a second bag, place the first bag in the second and seal it.
- Clean the area with plenty of water and keep cleaning with water and soap.
- Dispose of the hazardous material in accordance with the local legislation in force.

- *First aid in the event of contact with the electrolyte*

EYES

Immediately wash the eyes in abundant running water for at least 15 minutes, keeping the eyelids open and flushing the eye and back of the eyelid. Immediately seek medical help.

SKIN

Wash in cold water under a shower, remove contaminated garments. Continue washing for at least 15 minutes. Seek medical help where necessary.

RESPIRATORY TRACT

Move the casualty outdoors into the open air. If the casualty has difficulty breathing, have oxygen administered by trained personnel. If breathing stops, apply mouth-to-mouth resuscitation and immediately seek emergency medical help.

7.23.3.4 LITHIUM BATTERY FIRE

All metals may burn in certain conditions, which depend on certain factors such as: physical state, presence of oxidising atmospheres and severity of the source of ignition. Alkali metals such as lithium may burn in normal atmospheres. In addition, lithium reacts explosively with water to form hydrogen and the presence of small quantities of water may set fire to the material and the hydrogen gas that is released. Once metal fires start they are very hard to extinguish with ordinary equipment. This is partly due to the strong heat produced by the burning metal, whose temperature may reach 1000°C. In addition, lithium may react with certain materials commonly used in fire extinguishers, like water and CO₂.

Special extinguishers are required, designed for controlling and extinguishing lithium fires. In particular, graphite-based extinguishers (Lith-x) are used. Usually these extinguishers work by forming a crust or a layer of material on the surface of the burning metal. Lith-x, which is a common graphite-based agent, may be used with an extinguisher or spread over the fire. In the event of lithium fire, the room may fill with a dense white smoke, mostly formed by lithium oxide and other metal oxides. This condition may cause serious damage to the respiratory tract, skin and eyes. All precautions needed to limit exposure to these fumes must be adopted. It should be noted that this procedure is applicable only to fires on individual cells. Larger fires have to be managed only by professionally trained personnel. Finally, it should be noted that in the presence of combustible materials other than lithium it is advisable to use different types of extinguishers in conjunction to better ensure the extinguishing action of each on the appropriate material, however do not use water or CO₂ extinguishers directly on lithium fires.

• *Minimum equipment required*

- Class D fire extinguisher
- Class ABC extinguisher for any secondary fires
- Breathing apparatus
- Fireproof clothing
- Fireproof gloves
- Mask or protective glasses
- Non-conductive pliers
- Dustpan, mineral oil

• *Procedure*

- In the event of fire on one cell, a team of experienced fire-fighting personnel has to be contacted. The personnel must be properly trained to fight lithium battery fires.
- Evacuate personnel from all areas and sound the fire alarm.
- The fire-fighting personnel go to the area where the fire is located and gather all the information regarding the situation and the person who gave the alarm.
- Quarantine the area. Air the rooms until the burning material has been removed from the area and the characteristic pungent odour has disappeared.
- Two members of the team enter the area with appropriate safety equipment.

Note: lithium melts at 180°C. It becomes highly reactive and when it catches fire it may eject molten lithium particles. For this reason the surrounding cells may overheat and cause a violent explosion. The fire-fighting personnel must pay attention to any dange-

rous materials located near the fire.

Completely cover the fire with extinguishing material. Never leave the fire unattended as it may develop again.

- If necessary, extinguish the secondary fires with suitable extinguishers.
- After all the material has burned and cooled down, carefully mix the residual material to prevent resumption of the fire.
- Put the material in a metal drum, cover the surface with plenty of extinguishing material. The residual material may contain unreacted lithium, therefore limit exposure to rain by covering, for example, with mineral oil.
- Wear safety equipment: coat, gloves, mask and filters.
- The area around the cell will be covered by a black carbonaceous deposit which contains metallic parts of the cell. Cover the carbonaceous residue with a 50/50 mixture of soda and vermiculite or other absorbent material. Avoid contact between the metallic residue and charged cells as this condition may cause a short-circuit.
- Place the contaminated material in a sealable plastic bag and remove the excess air. Seal the bag.
- Place a cup of vermiculite in a second bag, place the first bag in the second and seal it.
- Clean the area with plenty of water and keep cleaning with water and soap.
- Dispose of hazardous material in accordance with the local legislation in force.

• *First aid in the event of contact with the electrolyte*

EYES

Immediately wash the eyes in abundant running water for at least 15 minutes, keeping the eyelids open and flushing the eye and back of the eyelid. Immediately seek medical help.

SKIN

Wash in cold water under a shower, remove contaminated garments. Continue washing for at least 15 minutes. Seek medical help where necessary.

RESPIRATORY TRACT

Move the casualty outdoors into the open air. If the casualty has difficulty breathing, have oxygen administered by trained personnel. If breathing stops apply mouth-to-mouth resuscitation and immediately seek emergency medical help.

7.24 SERVICING THE ENGINE THERMIC VERSION

Refer to the engine manual provided herewith.



WARNING

AFTER ANY MAINTENANCE OPERATION, BEFORE USING THE MACHINE TO WORK AT A HEIGHT IT IS COMPULSORY TO PERFORM ALL THE MOVEMENTS CONTROLLING THEM FROM THE GROUND, IN ORDER TO MAKE SURE THAT THE HYDRAULIC AND ELECTRICAL SYSTEM ARE IN GOOD WORKING ORDER. MAKE SURE THAT ALL THE SAFETY DEVICES ARE FUNCTIONING AND ARE CORRECTLY SHOWN ON THE REMOTE CONTROL. FURTHERMORE, AFTER PERFORMING A SERIES OF MOVEMENTS, CHECK AGAIN THE BALANCE AND THE DEGREE OF TENSION OF THE ROPES, AS WELL AS THE CENTERING OF THE EXTENSION ARMS.

ONLY THEN WILL THE MACHINE BE READY FOR USE.

8 SAFETY STANDARDS FOR TRANSPORT



IMPORTANT

Always make sure that the vehicle used to transport the platform has suitable capacity and that no part of the MEWP protrudes from the size limits prescribed by the road traffic regulations.

DURING TRANSPORT, COVER THE REMOTE CONTROL WITH THE SPECIAL PROTECTION CASING PROVIDED, OR DISCONNECT IT AND STORE IT IN A SAFE PLACE.

8.1 REMOVING THE BASKET

The basket can only be removed to allow transit through openings measuring between 1500 and 990 mm.



IF THE MACHINE IS WITHOUT BASKET, ONLY THE TRACKS CAN BE MOVED, KEEPING AT A MINIMUM DISTANCE OF 1 METRE FROM THE MACHINE.

To remove the basket, proceed as follows:

- remove the remote control from the support;
- loosen the aluminium covers on the basket fixing pins (see photo);



- withdraw the basket from above.

Reassemble the basket as follows:

- fit the basket into the fixing pins on the basket support, making sure that it moves downwards as parallel to the basket support as possible.



- **Tighten the two aluminium covers.**

8.2 LOADING AND UNLOADING THE MACHINE ON TRANSPORT VEHICLES USING RAMPS

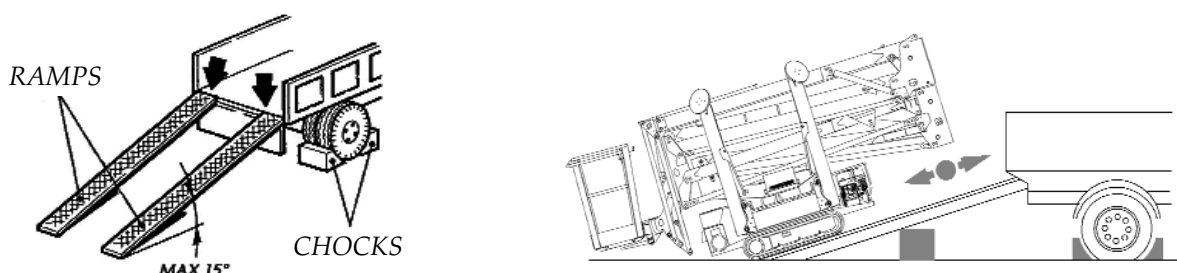

The HINOWA platform offers high manoeuvrability and stability even in travelling configuration. Despite this, the user must work with care even when carrying out the simplest operations.

During the phases of loading and unloading with ramps from lorry or trailer follow these instructions:

- Make sure that the lorry or trailer is rated for MEWP transport. Refer to the weight indicated in the technical specifications section of this manual.
- Park the lorry or trailer on a flat surface.
- Select ramps of adequate length to ensure a maximum angle of inclination as to the ground less than or equal to 15°. As a general rule, if the ramps and the lorry/trailer lean on a surface without slope variations, this requirement is met, if the ratio between the length of the ramps and the height of ground arrival floor is equal to or greater than 3.3.
- Make sure that the ramps are quipped with retaining lateral profile with shape and dimensions as per following drawing:

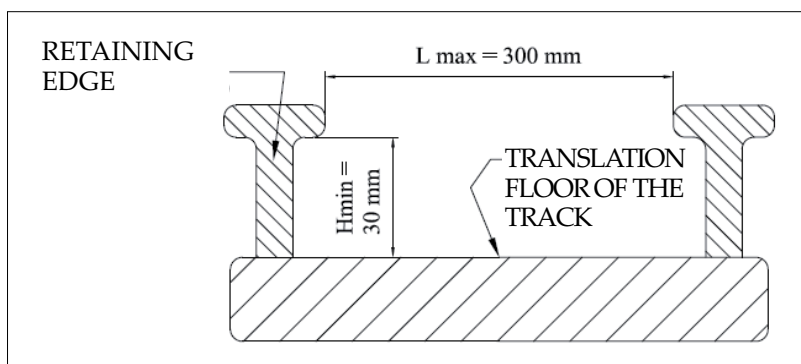

- Ensure that the ramps have an adequate capacity to support the machine. Refer to the weight indicated in the technical specifications section of this manual.
- Ensure that the ramps and transport and load floor of the lorry or retailer are free from waste or slippery material.
- The lorry or trailer must be stationary with wheels locked, parking brake on, engine off, without ignition key in the panel and with box flat.
- The ramps must be firmly supported and fixed to the structure of the arrival plan. Check

the validity of the connection to the lorry/retailer before using the ramps.

- The highest point of the ramp must be coplanar with the surface of arrival. No steps shall be present in the transit from the ramp to the arrival/departure plane.
- Open the undercarriage of the platform before approaching the ramps
- Adjust the distance of the ramps as to the rut of the two tracks
- Always empty the cage before approaching the ramps



IMPORTANT

- Climb the ramps proceeding with the machine oriented with cage toward the rear.



IMPORTANT

- In proximity of inclination variation between ramp and lorry/trailer floor, proceed very carefully in order to avoid jolts.



IMPORTANT

- Proceed slowly on the ramps adjusting the speed with the proportional levers. In the slope changes proceed with the MINIMUM speed possible. ENSURE THAT THE ENGINE ROTATES AT THE MIN. SPEED (accelerator lever positioned on turtle). Maintain a constant speed. Avoid sudden starting and braking.
Before proceeding on the ramps make sure that each track is Fully contained on the surface of each ramp. Taking the ramps proceed with a PERFECTLY straight trajectory taking care to check that ALWAYS each track is COMPLETELY contained on the surface of each ramp.
- Position the machine so that nothing comes out of the outline of the means of transport .

For the descent proceed following the indications and rules above written.



IMPORTANT

During the phases of translation and inclination change pay attention not to damage the safety devices placed under the cage and near the end of the first extension. In case the change of inclination is too big, change the inclination of the ramps or, if it is not possible, use longer ramps.

8.3 LIFTING THE MACHINE

To lift the machine, first of all a lifting device is required that has a suitable capacity depending on the distance and the height to which the MEWP is to be lifted.



- For lifting operations necessary for maintenance or loading onto transport vehicles, only use machinery (e.g. forklifts, crane, overhead cranes etc.) and load pick-up devices (e.g. ropes, chains, hooks) with suitable capacity and in perfect working order; for the weight of the machine, consult the paragraph relative to the technical features of the MEWP. The photograph shown below shows how and where the MEWP must be attached.
- When lifting the machine, it must be in transport configuration (extensible structure completely closed and aligned, stabilisers completely lifted and undercarriage extended). Otherwise, the machine would be unbalanced and lifting dangerous.
- Never lift the machine with the operator on board.
- During lifting, make sure that no people are in the area affected by the operations and do not move the suspended machine over persons.



IMPORTANT

Never lift the machine if it is not secured as shown herein; if, for example, it were lifted by attaching it to the arm, using devices for anchorage to the ground (above all not designed to support the weight of the MEWP) or simply passing a strap around any element of the arm, the turntable and other machine parts would be loaded with forces they are not designed for. There is a high risk of damaging the machine.

8.3.1 LIFTING THE MACHINE USING A FORKLIFT

The machine is equipped with two tubulars designed to lift the machine using a forklift of suitable capacity.



It is absolutely forbidden to lift the machine if it is not completely closed and aligned in transport position with the 4 stabilizers completely closed and lifted from ground.

Before proceeding verify the weight of the machine in the technical data of this manual and make sure that the forklift is suitable for this weight. Verify also the dimensions of the forks and make sure that the positioning of the load is in compliance with the requirements of the forklift.

Proceed approaching carefully to the machine paying attention not to collide with parts of it and cause damages to the structure.

During the operations of lifting and transport follow the requirements and dispositions prescribed for the use of the lifting device and/or by the security officer of the working environment in which the operation is performed.

This operation must be performed by appropriate personnel possessing the regulatory requirements to the use of the lifting device chosen.



IMPORTANT

The manufacturer of the Platform is not responsible in any way for damages caused to the machine, lifting device or persons and/or objects due to improper execution of this operation.

8.3.2 LIFTING THE MACHINE USING ROPES OR CHAINS

To lift the platform it must be attached to each stabiliser using the appropriate fixing rings as indicated in the photo below.

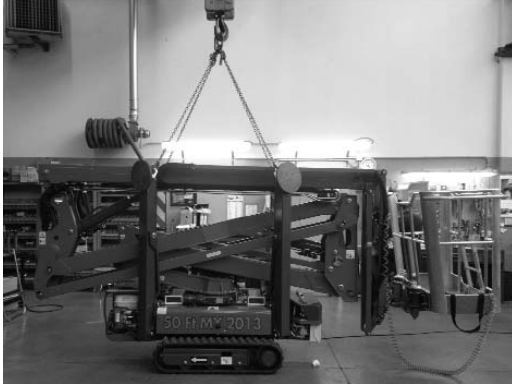

DANGER

All four feet must be attached, otherwise the machine may not be balanced. Moreover, it is obligatory to use four different ropes, chains or slings; in this way, breakage or incorrect anchorage of one connection device would not cause dangerous load movements.

The lifting devices must be in good working order and used according to the specifications supplied by the manufacturer. As the weight of the platform is not distributed equally over the four stabilisers, the minimum required capacity for the four ropes, chains or slings used must not be less than 2000 kg and they must be minimum 3 m long and all identical.

The slings cannot be more than 60 mm wide, the chains not more than 25 mm, and the rope diameter cannot exceed 25 mm.



IMPORTANT

The use of ropes, chains or slings less than 3 m long may cause permanent damage to the machine stabilisers.

8.4 TRANSPORTING THE MACHINE

Once on the trailer the machine must be fixed using tie rods as shown in the photo below. Make sure that the dimensions of the machine and the trailer are compatible with road traffic regulations.



The fixing system connection points are identified by the sticker.

Do not make connections in points other than those identified by the sticker. This could cause permanent damage to the structure with risk of collapse.



9 SERVICE MENU ON THE REMOTE CONTROL

A SERVICE button is available on the remote control (ref. button 6) and is used to display the status of the machine parameters and as assisting device for the safety checks to be carried out on the machine, as specified in this manual.

Pressing button 6 accesses a numerical menu, controlled by the number buttons on the remote control. The meaning of these menus is explained in this manual. If after reading the manual you still have some doubts, contact the HINOWA after-sales service.

- 1 INPUT**
- 2 LANGUAGE**
- 3 ERRORS**
- 4 RAMPS**
- 5 CURRENT**
- 6 OP. HOURS**
- 7 SETTINGS**
- 8 JOYSTICK**
- 9 EXIT**

MENUS 4 AND 5 ARE NOT ACCESSIBLE

9.1 INPUT MENU

This displays the signals received by the board from the various sensors fitted on the machine and from the controls on the remote control. Each screen shows the status of the input and options to scroll the menu:

- 1 PREC access the previous input
- 2 SUCC access the next input
- 9 ESCI exit the INPUT menu

ST TERR 1A	If both are ON, stabiliser 1 is resting on the ground.
ST TERR 1B	
ST TERR 2A	If both are ON, stabiliser 2 is resting on the ground
ST TERR 2B	
ST TERR 3A	If both are ON, stabiliser 3 is resting on the ground
ST TERR 3B	
ST TERR 4A	If both are ON, stabiliser 4 is resting on the ground
ST TERR 4B	
ST APERT1A	ND
ST APERT1B	
ST APERT2A	ND
ST APERT2B	
ST APERT3A	ND
ST APERT3B	
ST APERT4A	ND
ST APERT4B	

SELF-PROPELLED TRACKED PLATFORM LL1775

HINOWA

ESSICAE A	If both are ON, the safety devices for the aerial part have been disabled using special key.
ESSICAE B	
ESSICCA A	If both are ON, the safety devices for the carriage have been disabled using special key.
ESSICCA B	
EM.TERRA A	If both are ON, the emergency STOP from the ground has NOT been pressed.
EM.TERRA B	
FOTOA	If both are ON, the photoelectric cells are aligned
FOTOB	
EMTEL TERR	If ON, the emergency STOP on the remote control from the ground is NOT pressed.
ST1-2 CHIUSI	If ON, stabilisers 1-2 are completely raised and pressurised.
ST3-4 CHIUSI	If ON, stabilisers 3-2 are completely raised and pressurised.
ALL.TEMP A	If both are ON, the outside temperature probe is in alarm condition (Russian version only).
ALL.TEMP B	
ALTERN.	ON or OFF depending on whether the motor is on or off.
COM EMERG	If ON, the emergency controls are active (key turned on panel).
MICROFUNI	If ON, both cables are working.
MARCIA MOTO	If ON, the motor start button on the ground position is pressed.
TEMP.MOTO	If OFF with motor on, the alarm is active.
PRESS.MOTO	If ON with motor on, the alarm is active
TER/NAV A	If ON, the remote control from the ground position has been enabled using special
MICROJIB A	If both are ON, the jib arm is completely folded.
MICROJIB B	
PEDALE	If ON, the pedal in the basket is pressed (pedal version only).
EMNAV A	If both are ON, the emergency STOP on the remote control in the basket is NOT pressed.
EMNAV B	
POSM 1A	If both are ON, stabiliser 1 is lowered (stabilisation position).
POSM 1B	
POSM 2A	If both are ON, stabiliser 2 is lowered (stabilisation position).
POSM 2B	
POSM 3A	If both are ON, stabiliser 3 is lowered (stabilisation position).
POSM 3B	
POSM 4A	If both are ON, stabiliser 4 is lowered (stabilisation position).
POSM 4B	
TEL.CESTO	If ON, the remote control is in place in the basket.
INCLIN. X	Indicates the incline of the X axis in tenths of a degree
INCLIN. Y	Indicates the incline of the Y axis in tenths of a degree
PESO.	Indicates the weight in the basket in kg.
POS. 1E2	ND
POS. 3	Indicates the stroke of the 3rd arm cylinder in tenths of a millimetre
ROTAZ A	ND
MOTORE RPM	Indicates the motor speed.
CORRENTE A	Indicates the power supply to the proportional valve.
CORRENTE B	Indicates the power supply to the proportional valve.
CORRENTE C	Indicates the power supply to the proportional valve.
TEMPERAT.	Indicates the temperature measured by the electronic probe on board.
ALIMENT(V)	Indicates the power supply voltage in Volts.

9.2 ERROR MENU

Indicates correspondence between the double sensors, either (OK) or (FAULT).

The sensors are listed on different pages:

1 PREC ACCESS THE PREVIOUS PAGE

2 SUCC ACCESS THE SUCCESSIVE PAGE

9 EXIT

If the OK symbol is shown next to the sensor, this means that both elements on the same sensor are sending congruent information.

If the FAULT symbol is shown next to the sensor, this means that the elements on the same sensor are sending incongruent information.

The last page of the error menu describes the error code relating to the battery charger system, inverter and battery pack. Errors are indicated by the “spanner” icon in position 7 on the remote control display.

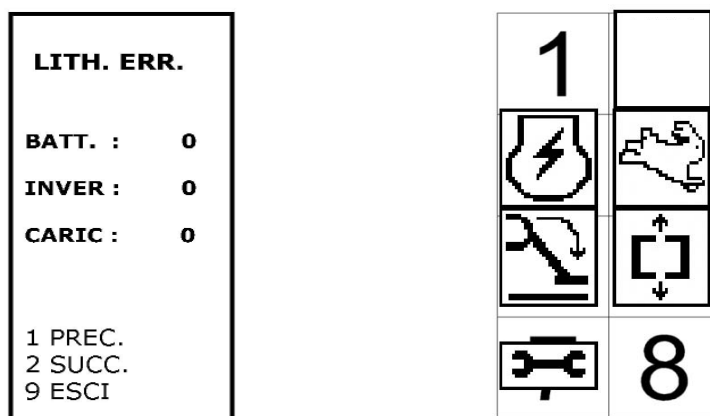

If there are operating problems with the machine and the “spanner” icon is shown on the display, contact service department.

9.3 OPERATING HOURS MENU

Indicates the number of machine operating hours.

9.4 SETTINGS MENU

The items in this menu are not normally accessible.

9.5 JOYSTICK MENU

Displays the signal that each individual joystick sends to the main board.

10. TROUBLESHOOTING

FAULT	CAUSE	SOLUTION
The pump is very noisy.	<ul style="list-style-type: none"> • No pump intake • Pump excessively worn • Pump takes in air 	<ul style="list-style-type: none"> • Replace pump • Check oil level in the tank
On activating the pump no oil is delivered to the hydraulic system or it is not sufficiently pressurised to move the machine	<ul style="list-style-type: none"> • See point 1 • Maximum pressure valves not set or dirty • Maximum pressure valve seals worn • No correspondence between remote control insertion point and position of key for selecting the control position 	<ul style="list-style-type: none"> • See point 1 • Set or clean maximum pressure valves • Replace maximum pressure valves • Check key position • Replace fuses
Once machine has been stabilised, the aerial part cannot be removed from the supports in the rest position	<ul style="list-style-type: none"> • See point 2 • Contacts on the stabiliser microswitches don't close • Machine not level within the tolerance of 1°. • Emergency stop in the basket not correctly in place 	<ul style="list-style-type: none"> • See point 2 • Adjust microswitches on stabilisers • Level machine within the tolerance of 1°. • Check emergency stop contact key in the basket • Dismantle and clean stop valves on rams that won't support the load
The machine upper structure cannot support the work platform with the rated load on board	<ul style="list-style-type: none"> • Dirty or faulty stop valve 	<ul style="list-style-type: none"> • Reset emergency button that was pressed
When operating the aerial part the machine stops and won't move	<ul style="list-style-type: none"> • Emergency button accidentally pressed • Load cell activated • One stabiliser lost contact with ground 	<ul style="list-style-type: none"> • Restore the neutral position of the pressed emergency button • Unload machine • Follow emergency procedure

SELF-PROPELLED TRACKED PLATFORM LL1775

HINOWA

FAULT	CAUSE	SOLUTION
After work the stabilisers cannot be raised	<ul style="list-style-type: none">• Aerial part has not been put perfectly at rest• Photoelectric cells faulty/poorly adjusted	<ul style="list-style-type: none">• Repeat procedure to place aerial part at rest and check correct signal from photoelectric cells
When operating the aerial part vibrations and juddering are felt when extending and retracting the arm	<ul style="list-style-type: none">• Telescopic arm and slides poorly lubricated• Slides worn	<ul style="list-style-type: none">• Lubricate arm and slides• Adjust slides
The work platform does not remain level when moving the arm	<ul style="list-style-type: none">• Air in levelling system• Balance valve on levelling system faulty or not properly set	<ul style="list-style-type: none">• Bleed air from work platform levelling system (contact our service department)• Replace balance valve on work platform levelling system.
Uneven movement of the first and second arm	<ul style="list-style-type: none">• Accumulator discharged	<ul style="list-style-type: none">• Replace accumulator (contact our service department).

ALARMS

INVERTER FAULT CODES

CODE	MEANING
1	Wrong Config Cause: EEPROM memory not configured. Solution: Contact after-sales service.
8	Watch Dog Cause: Inverter cannot start or stop electric motor. Solution: Check connections and continuity of electric motor. If OK, replace inverter.
13	Eeprom KO Cause: EEPROM hardware or software problem. Solution: Replace inverter.
16	Aux output KO Cause: Problem with electromechanical brake. Solution: This is generally a temporary problem due to certain working conditions. If problem persists, replace inverter.
17	Logic failure #3 Cause: Activated in the event of high inverter current peaks. Solution: This is generally a temporary problem due to certain working conditions. If problem persists, replace inverter.
18	Logic Failure #2 Cause: Internal fault in the inverter. Solution: Replace inverter.
19	Logic failure #1 Cause: Sudden voltage surge or voltage drop. Solution: This is a temporary problem due to certain working conditions. If problem persists, replace inverter.
30	VMN low Cause: Inverter power supply voltage is lower than battery voltage, or alternatively incorrect connection to positive battery pole. Solution: Check connection to positive battery pole. If problem persists, replace inverter.
31	VMN High Cause: One motor phase not connected correctly or faulty. Solution: Check motor phases. If problem persists, replace inverter.

SELF-PROPELLED TRACKED PLATFORM LL1775

HINOWA

CODE	MEANING
37	Contactor closed Cause: Relay remains closed when power to coil is disconnected. Solution: Check relay.
38	Contactor Open Cause: Inverter supplies power to relay coil but contact doesn't close. Solution: Check relay and power supply to coil.
49	I=0 Ever Cause: Feedback current from motor sensor not constantly at 0. Solution: Check connection to motor.
53	STBY I high Cause: Internal fault detected in the inverter. Solution: This is generally a temporary problem due to certain working conditions. If problem persists, replace inverter.
60	Capacitor Charge Cause: Internal fault in the inverter. Solution: Check connections and motor phases.
61	High temperature Cause: High temperature inside the inverter. Solution: Improve cooling to inverter. If fault persists, contact after-sales service.
65	Motor temperat Cause: High motor temperature. Solution: Temporarily stop machine to allow motor to cool down.
67	Can Bus KO Cause: Inverter doesn't receive any information from Can Bus line. Solution: Check connections using multifunction tester.
70	Encoder Error Cause: Problem detected with encoder (=motor speed sensor). Solution: Check speed sensor connection. Anomaly may also have been caused by fault with bearing.
73	Thermis sensor KO Cause: Signal from temperature sensor greater than 4.95 Volts or less than 0.1 Volt. Solution: This is generally a temporary problem due to certain working conditions. If problem persists, replace inverter.

SELF-PROPELLED TRACKED PLATFORM LL1775

HINOWA

CODE	MEANING
74	Driver shorted Cause: Relay power supply fault. Solution: Check relay power supply. This is generally a temporary problem due to certain working conditions. If problem persists, replace inverter.
75	Driver shorted Cause: Relay power supply fault. Solution: Check relay power supply. This is generally a temporary problem due to certain working conditions. If problem persists, replace inverter.
76	Coil shorted Cause: Problem detected with relay coil. Solution: Make sure relay coil is intact.
78	VACC not OK Cause: Solution: This is generally a temporary problem due to certain working conditions. If problem persists, replace inverter.
79	Incorrect start Cause: Incorrect starting procedure. Solution: Check electrical connections. This is generally a temporary problem due to certain working conditions. If problem persists, replace inverter.
86	Pedal wire KO Cause: Solution: This is generally a temporary problem due to certain working conditions. If problem persists, replace inverter.
93	Wrong set batt Cause: With power connected, battery test detected incorrect batteries fitted. Solution: Replace batteries with the original ones.
94	Current sensor KO Cause: Set up procedure for maximum current in progress. Solution: Contact after-sales service.
99	Check up needed Cause: Solution: Contact after-sales service.

N.B.: the CODE column indicates the CAN CODE in the message sent by the battery charger. The normal mains voltage tolerance is the rated value $\pm 15\%$.

BMS FAULT CODES

<u>CODE</u>	<u>TYPE OF ERROR</u>
A99E01	Configuration error
A99E02	Incorrect voltage
A99E03	Incorrect temperature
A99E04	Excess discharge current
A99E05	Excess charge current
A99E06	Pre-charge error
A99E07	No 12 V power supply
A99E08	No 12 V power supply
A99E09	High battery compartment temperature
A99E10	High electronic board temperature
A99E11	Incorrect self-protection device temperature
A99E12	Fault on all temperature sensors
A99E13	Temperature sensor fault
A99E14	Earth connection fault
A99E15	Bootloader error
A99E16	Secondary protection
A99E17	Control device error
A99E18	Power board error
A99E19	I2C module not ready
A99E20	I2C TX error
A99E21	I2C RX error
A99E22	I2C RX error 2
A99E23	AD error
A99E99	General error

BATTERY CHARGER FAULT CODES

CODE	DESCRIPTION	STATUS	ACTION
8	Internal logic fault.	Battery charger stops working.	Contact service dept. or change product.
13	Communication problem with external memory.	Battery charger stops working.	Contact service dept. or change product.
19	Internal logic fault.	Battery charger stops working.	Contact service dept. or change product.
242	Error when reading internal memory on microcontroller.	Battery charger stops working.	Contact service dept. or change product.
252	Short-circuit in battery charger output.	Battery charger stops working.	Turn off battery charger and resolve short-circuit at output. If problem persists, contact service dept. or change product.
246	Stage 1 ended by timeout without reaching control voltage.	Battery charger stops working.	Make sure battery capacity is compatible or check that battery is compliant with battery charger. If battery is correct and problem persists, contact service dept.
241	Problem in CANBUS communication with other systems in the network.	The way this is managed may change based on different firmware releases.	Check correct operation of CANBUS system.

SELF-PROPELLED TRACKED PLATFORM LL1775

HINOWA

CODE	DESCRIPTION	STATUS	ACTION
248	Temperature inside battery charger too high.	If internal temperature exceeds 80°C, battery charger reduces power to 80%, while it stops operating altogether if internal temperature exceeds 90°C. Battery charger starts at full power again when internal temperature falls below 70°C.	
249	Battery temperature too high.	If temperature exceeds 55°C or is less than -20°C, battery charger stops working. When battery temperature falls below 45°C or exceeds -10°C battery charger resumes normal operation.	
251	Power failure detected.	Battery charger stops supplying power. Operation resumes as soon as alarm conditions are no longer present.	If problem persists, check battery charger mains power supply.
242	Error when reading internal memory on microcontroller.	Battery charger stops working.	Contact service dept. or change product.
18	Extended shutdown or power failure.	Battery charger stops supplying power. Operation resumes as soon as alarm conditions are no longer present or after restarting.	If problem is a power failure, check battery charger mains power supply.
245	Abnormal current draw in primary section.	Battery charger stops supplying power. Operation resumes as soon as alarm conditions are no longer present.	If problem persists, contact service dept. or change product.
240	Digital input is open and managed as hardware start-stop.	Battery charger stops charging until digital input closes.	Close digital input.

CODE	DESCRIPTION	STATUS	ACTION
253	Mains voltage higher than maximum operating range tolerance.	Battery charger won't start charging until mains voltage returns within normal operating range.	Make sure mains voltage is within correct operating parameters.
244	Mains voltage lower than maximum operating range tolerance.	Battery charger won't start charging until mains voltage returns within normal operating range.	Make sure mains voltage is within correct operating parameters.

11. CHECKS TO BE COMPLETED ON THE MACHINE FOLLOWING REPAIRS

11.1 CHECKING CORRECT OPERATION OF THE CONTROLS

- From the ground make sure that the controls operate the machine smoothly.
- For correct operation of the controls, see the relevant paragraph.

11.2 CHECKING OPERATION OF THE SAFETY DEVICES

Make sure that all the safety devices work as described in this manual.

12. HYDRAULIC SYSTEM

12.1 HYDRAULIC SYSTEM DIAGRAM THERMIC VERSION

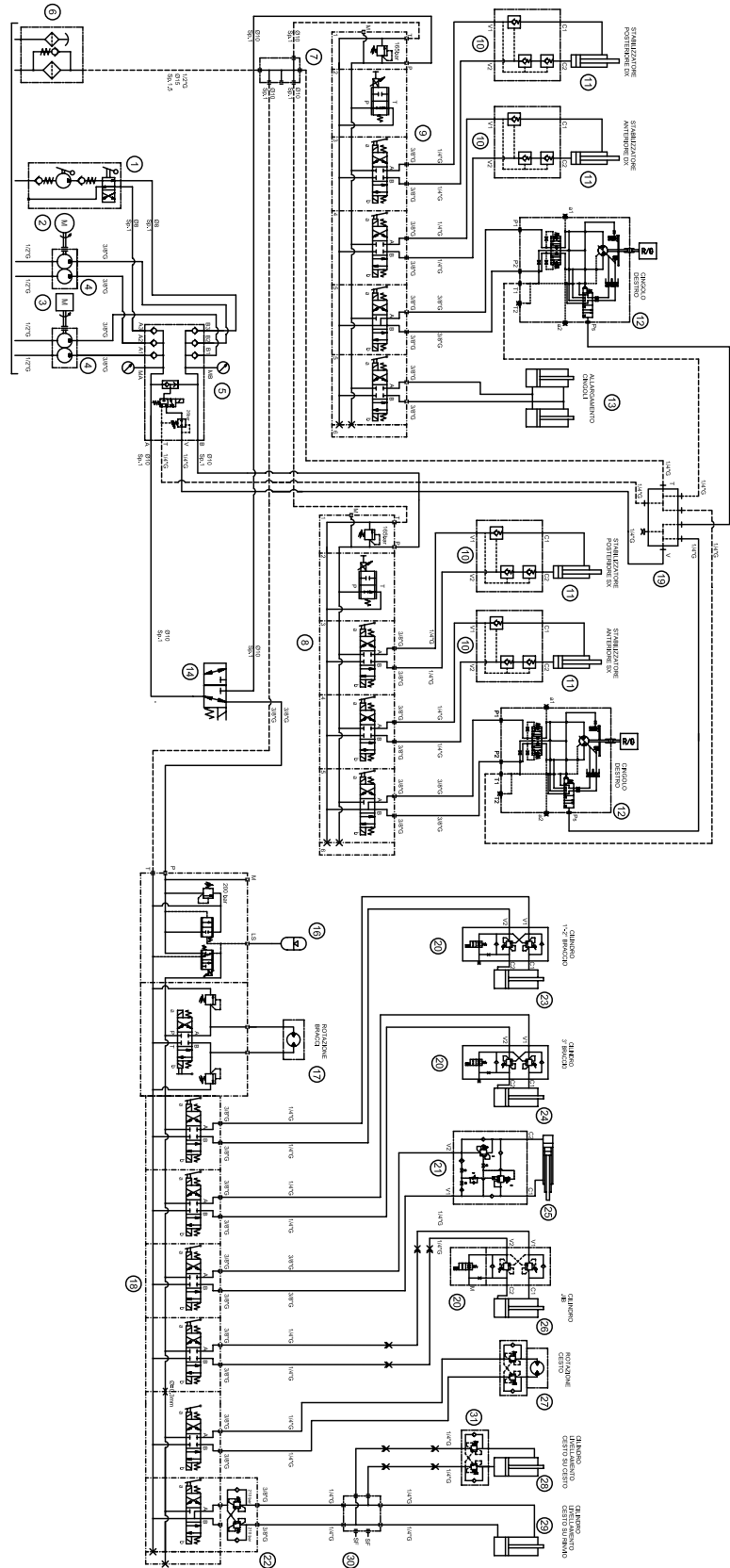

12.1.1 KEY TO THE HYDRAULIC SYSTEM DIAGRAM THERMIC VERSION

- 1 Hand pump
- 2 2.2 kW 4 pole electric motor, IP55
- 3 Honda iGX440 petrol engine / Hatz 1B40 diesel engine
- 4 Double gear pump
- 5 Pump outlet manifold block
- 6 Discharge filter
- 7 Discharge manifold
- 8 Distributor
- 9 Distributor
- 10 Stabiliser stop valve
- 11 Stabiliser cylinder
- 12 Gear motor
- 13 Track gauge extension cylinder
- 14 Directional solenoid valve
- 15 Rotation distributor
- 16 Accumulator
- 17 Rotation motor
- 18 Distributor
- 19 Manifold
- 20 Balancing valve double arms
- 21 Regenerative extension balancing valve
- 22 Double balance valve
- 23 First-second arm cylinder
- 24 Third-fourth arm cylinder
- 25 Extension arm cylinder
- 26 Jib cylinder
- 27 Rotary actuator for basket rotation
- 28 Basket levelling cylinder on the basket
- 29 Basket levelling cylinder on the transmission
- 30 Deflection block for closed loop
- 31 Double adjusting valve for levelling

12.2.1 KEY TO THE HYDRAULIC SYSTEM DIAGRAM LITHIUM VERSION

- 1 Hand pump
- 2 Electric motor
- 4 Double gear pump
- 5 Pump outlet manifold block
- 6 Discharge filter
- 7 Discharge manifold
- 8 Distributor
- 9 Distributor
- 10 Stabiliser stop valve
- 11 Stabiliser cylinder
- 12 Gear motor
- 13 Cylinder widening track
- 14 Directional solenoid valve
- 15 Rotation distributor
- 16 Accumulator
- 17 Rotation motor
- 18 Aerial part distributor
- 19 Manifold
- 20 Balancing valve double arms
- 21 Regenerative extension balancing valve
- 22 Double balance valve
- 23 First-second arm cylinder
- 24 Third-fourth arm cylinder
- 25 Extension arm cylinder
- 26 Jib cylinder
- 27 Rotary actuator for basket rotation
- 28 Basket levelling cylinder on the basket
- 29 Basket levelling cylinder on the transmission
- 30 Deflection block for closed loop
- 31 Double adjusting valve for levelling

13 WIRING DIAGRAM

• PETROL AND DIESEL ENGINE WIRING DIAGRAM - THERMIC VERSION

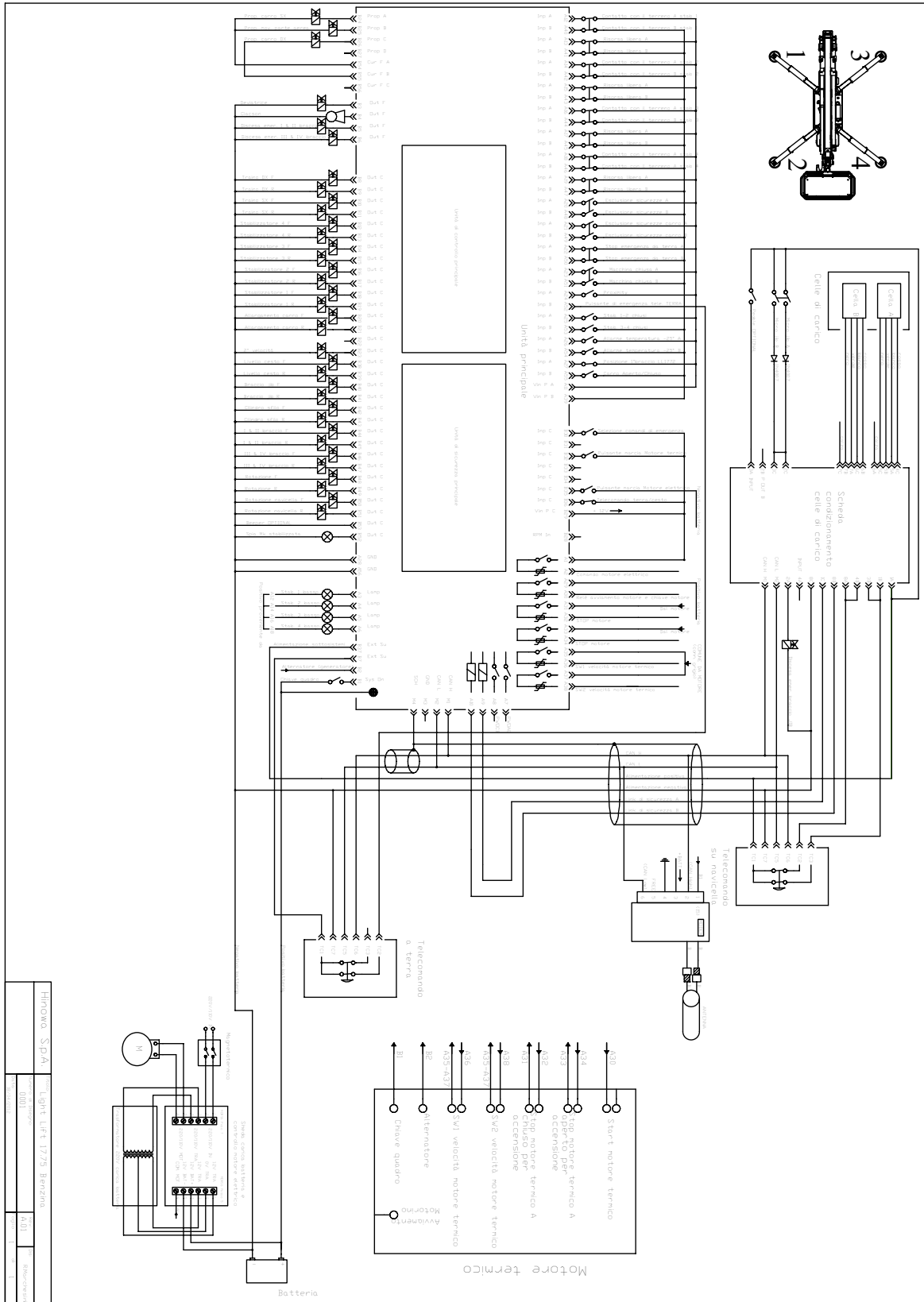

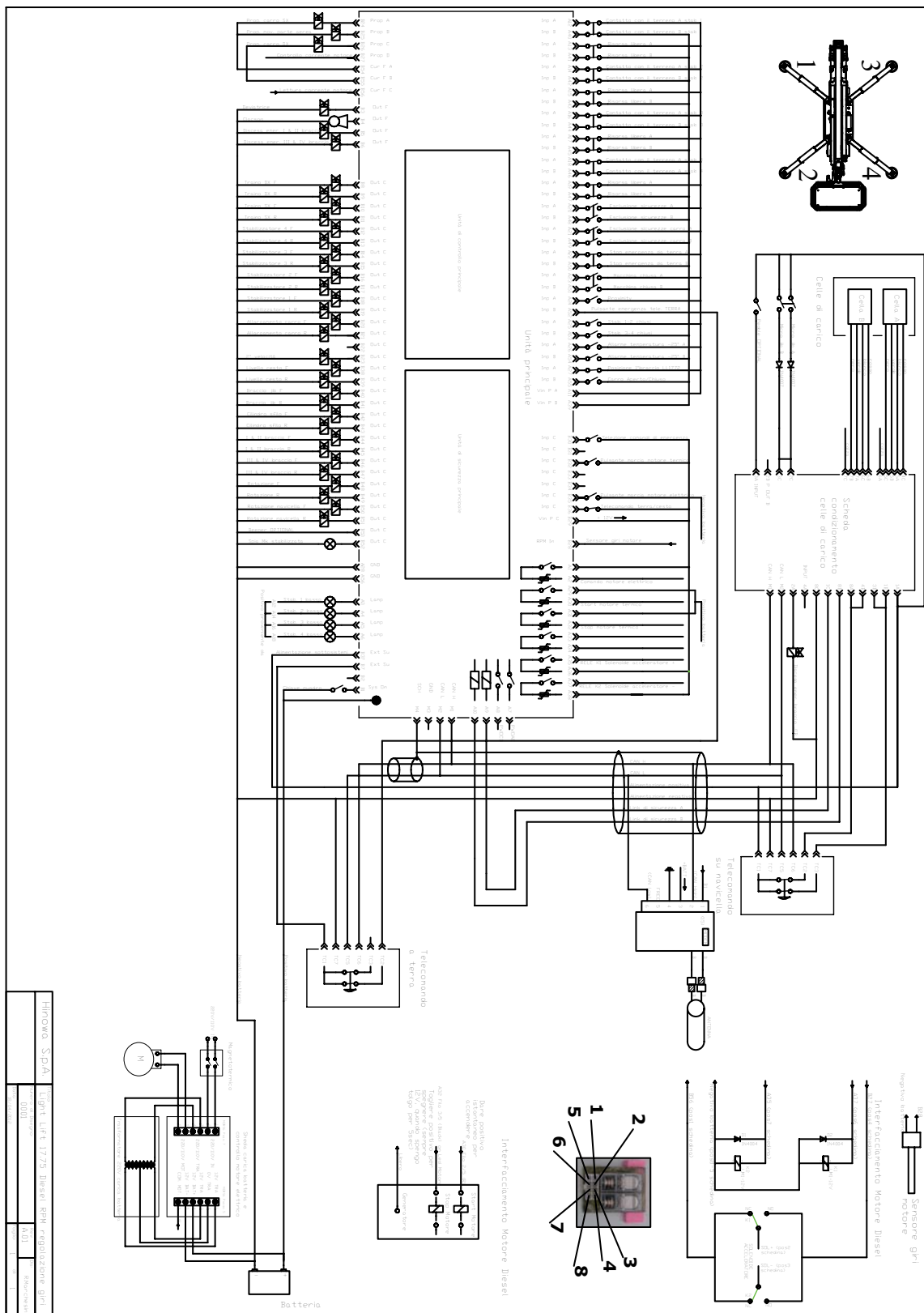

SELF-PROPELLED TRACKED PLATFORM LL1775

HINOWA

• ENGINE WIRING DIAGRAM - LITHIUM VERSION

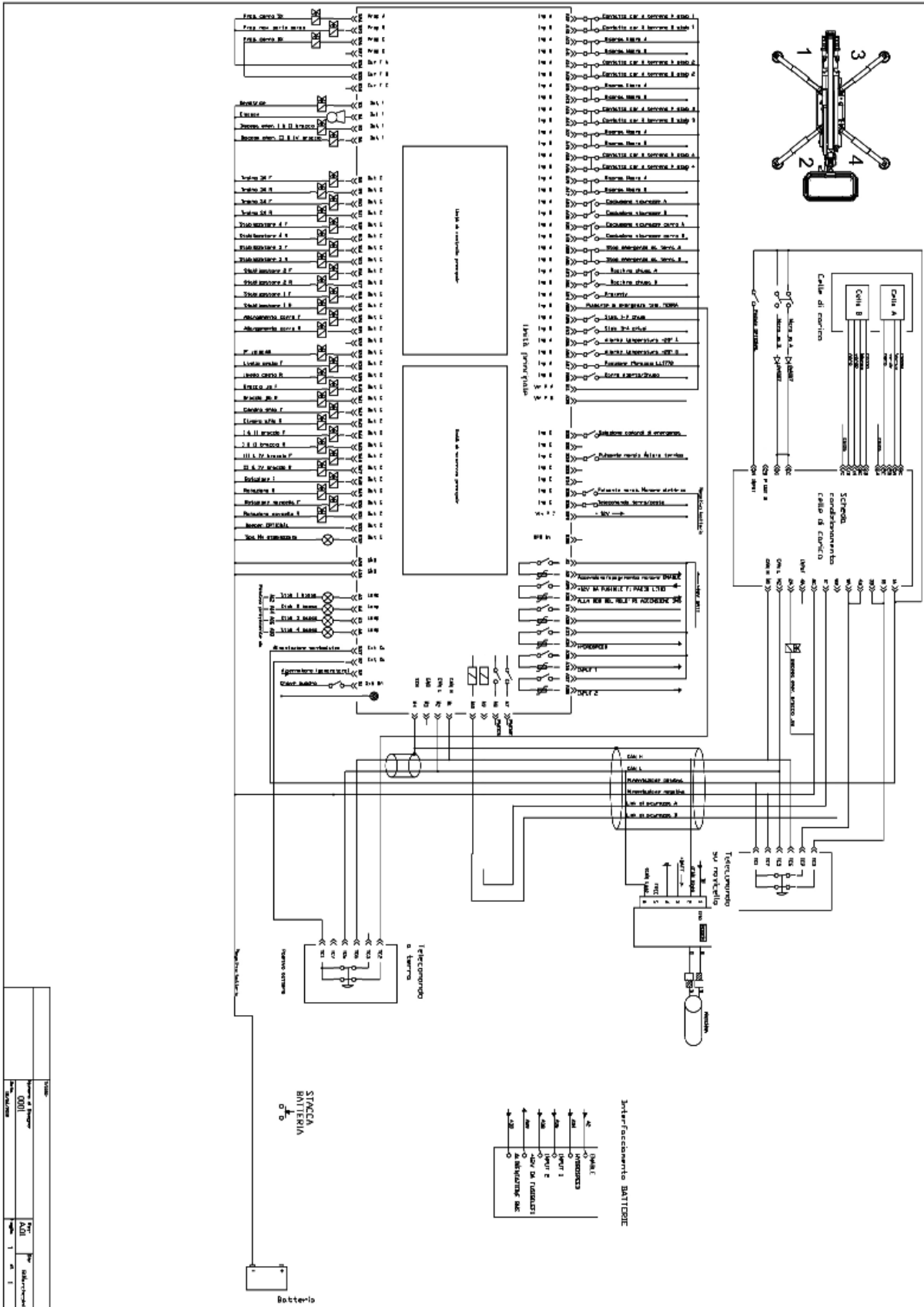



Legal and administrative seat:

HINOWA S.p.A.
I - 37054 NOGARA (VR) via Fontana
Tel. +39 0442 539100 Fax +39 0442 539075
hinowa@hinowa.it
marketing: info@hinowa.com
www.hinowa.com